

# InTech®

OFFICIAL PUBLICATION OF THE INTERNATIONAL SOCIETY OF AUTOMATION

APRIL 2023



[www.isa.org/intech](http://www.isa.org/intech)

## MODERN TOOLS CREATE MODERN SYSTEMS

How DCS Migration Improves Operator Experience

Plan to Modernize Plant Connectivity

Field-Level Comms Improve IIoT Systems

Advanced Analytics for Sustainability

Additive Manufacturing Creates Quieter Control Valves

AUTOMATION PRO

**\$ALARY  
\$URVEY**



Compare yourself with your peers.

Take the survey to get the report.



**A**UTOMATION  
COM

## FROM THE PUBLISHER: WELCOME!

As the official publication of International Society of Automation (ISA), *InTech* digital magazine serves ISA members and the wider automation community with practical, in-depth coverage of automation technologies, applications, and strategies that help automation professionals succeed.

*InTech* is written for engineers, managers, and other automation decision makers, and is brought to you 6x per year with the support of the advertisers shown at the right. Topics include industrial cybersecurity, process and machine control, smart manufacturing, Industry 4.0, IIoT and much more.

*InTech* advertisers support ISA and are pleased to provide additional information about their automation products and services. To obtain more information, click the logos shown to see the ads in the magazine. Then, on the ad page itself, click through to the vendor websites.

## Don't Miss a Single Issue

*InTech* digital magazine publishes six times per year. **ISA Members** [<https://www.isa.org/joinnow>] receive *InTech* digital magazine as part of their annual membership and get access to archived issues. Non-members can **subscribe** [<https://www.automation.com/subscribe>] to *InTech* and *InTech* Plus newsletters through ISA's automation news and information subsidiary, Automation.com.

**Rick Zabel, Managing Director**

*InTech*, *Automation.com* & Events Sponsorships  
International Society of Automation (ISA)

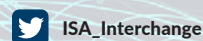

## Advertisers Index

*InTech* advertisers are pleased to provide additional information about their products and services. To obtain further information, please contact the advertiser using the contact information contained in their ads.



Page ..... 8, 43



Page ..... 5



Page ..... 7



Page ..... 37



A Rockwell Automation Company  
Page ..... 13



Page ..... 3



The Safety Company  
Page ..... 20



Page ..... 19



Page ..... 29



Page ..... 10



Page ..... 28

# KEEP IT SAFE



 **MOORE  
INDUSTRIES**  
WORLDWIDE  
*Demand Moore Reliability*

Keep your process and plant safe with FS Functional Safety Series instrumentation from Moore Industries. You can be confident that they will help ensure the safety of your process and facility when you need it the most. Our Logic Solver, Signal Isolators and Transmitters are built to strict IEC 61508 standards, ensuring safe and reliable operation – particularly in environments where hazardous or emergency situations are likely to occur.



The rugged and reliable FS Safety Series Instruments from Moore Industries.

To learn more about our **FS Functional Safety Series**, Call (800) 999-2900 or go to: [www.miinet.com/KeptSafe](http://www.miinet.com/KeptSafe)

## FEATURES

### OPERATIONS

#### 14 How DCS Migration Improves Operator Experience

By Scott Hayes and Fekri Abdullah

Operators can see, hear, and feel the effects of modern distributed control systems.

### DIGITAL TRANSFORMATION

#### 21 Modern Tools Create Modern Systems

By Aaron Crews

AI- and cloud-based engineering tools accelerate control system modernization efforts.

### CONNECTIVITY

#### 30 Prepare to Modernize Your Plant

By Ted Masters and Paul Sereiko

Change is coming. Newer standards for connectivity favor the early adopters.

### INDUSTRIAL IOT

#### 38 Field-Level Comms Improve IIoT Implementations

By Bill Dehner

Start incrementally at the edge by combining proven fieldbuses and controllers.



### INDUSTRY 4.0

#### 44 Advanced Analytics Drive Sustainability Initiatives

By Morgan Bowling

Leverage models and algorithms to reduce costs, waste, and carbon emissions.

### SMART MANUFACTURING

#### 50 How Additive Manufacturing Leads to Quieter Control Valves

By Grady Emswiler and Mike Hoyme

3D printing techniques enable quieter designs for final control elements.



We offer process application expertise through our products, solutions and services.

# SUPPORT + SUCCESS

You optimize your process for maximum safety, reliability and efficiency, with minimum impact on the environment.

Customers around the world trust us when it comes to process automation. Our shared goal is plant safety, availability and efficiency. We are with you every day, everywhere.

**People for Process Automation**

70  
years

The pulse of  
measurement  
technology

Do you want to learn more?  
[www.us.endress.com](http://www.us.endress.com)

Endress+Hauser 

## DEPARTMENTS

### 9 Talk to Me

By Renee Bassett

Keeping Up on Industry 4.0? Follow the Influencers

### 11 IIoT Insights

By Jim Cahill

Wireless Devices Drive Energy Optimization

### 55 Association News

- ISA Cybersecurity Summit Debuts in Scotland
- ISA Business Academy: Delivering Mini-MBA for Automation Professionals
- International Automation Professionals Celebrated in April
- ISA Security Compliance Institute Welcomes IriusRisk SL
- ISA Standards and the International Standards System

### 60 Final Say

By Bill Lydon

Work@Home Is Environmentally and Sustainably Responsible

## EDITORIAL & PRODUCTION

**CHIEF EDITOR:** Renee Bassett, [rbassett@isa.org](mailto:rbassett@isa.org)

**SENIOR CONTRIBUTING EDITOR:** Jack Smith, [jsmith@isa.org](mailto:jsmith@isa.org)

**CONTRIBUTING EDITORS:** Bill Lydon, [blydon@isa.org](mailto:blydon@isa.org)

Charley Robinson, [crobinson@isa.org](mailto:crobinson@isa.org)

**PRODUCTION EDITOR:** Lynn DeRocco

**ART DIRECTOR:** Bonnie Walker

**GRAPHIC DESIGNER:** Jamie McLendon

**DIGITAL DESIGNER:** Colleen Casper

## ISA MEMBER LEADERS

**ISA PRESIDENT:** Marty Bince

**ISA PAST PRESIDENT:** Carlos Mandolesi

**ISA PRESIDENT-ELECT & SECRETARY:** Prabhu Soundarrajan

**ISA TREASURER & PUBLICATIONS COMMITTEE CHAIR:**

Steve Mustard

## ADVERTISING & SPONSORSHIP

Rick Zabel, **PUBLISHER**

[rzabel@isa.org](mailto:rzabel@isa.org)

Chris Nelson, **ACCOUNT EXECUTIVE**

[chris@isa.org](mailto:chris@isa.org)

Richard T. Simpson, **ACCOUNT EXECUTIVE**

[richard@isa.org](mailto:richard@isa.org)

Gina DiFrancesco, **ACCOUNT EXECUTIVE**

[gina@isa.org](mailto:gina@isa.org)

Cathi Merritt, **ADVERTISING PRODUCT MANAGER**

[cmerritt@isa.org](mailto:cmerritt@isa.org)

Matt Davis, **DIGITAL MEDIA PROJECT MANAGER**

[mdavis@isa.org](mailto:mdavis@isa.org)



### 2023 Media Planner

To order reprints of *InTech* print or digital articles, contact [reprints@mossbergco.com](mailto:reprints@mossbergco.com) or 800-428-3340.

©2023 International Society of Automation (ISA) ISSN 0192-303X

Editorial and advertising offices are at 3252 S. Miami Boulevard, Suite 102, Durham, NC 27703; phone 919-549-8411; email [info@isa.org](mailto:info@isa.org).

*InTech* digital magazine publishes six times per year. **ISA Members** [<https://www.isa.org/joinnow>] receive *InTech* digital magazine as part of their annual membership and get access to archived issues. Non-members can **subscribe** [<https://www.automation.com/subscribe>] to *InTech* and *InTech Plus* newsletters through ISA's automation news and information subsidiary, Automation.com. *InTech* and the ISA logo are registered trademarks of ISA.

Trademarks used in this document are the property of their respective owners. Opinions expressed or implied are those of the persons or organizations contributing the information and are not to be construed as those of ISA.



**International Society of Automation**  
Setting the Standard for Automation™

# The Plant Floor in Your Pocket

Get an overview of your process at a glance.  
Control your SCADA with a swipe.



See the live demo now.  
Scan this QR code with your phone  
or visit [demo.ia.io/tech](https://demo.ia.io/tech)





## OT CYBERSECURITY SUMMIT

**PROTECT YOUR  
FORTRESS**

**31 May – 1 June 2023 | Ardoe House Hotel & Spa, Aberdeen, Scotland**

This brand new event will focus on how you can protect your fortress with the ISA 62443 series of standards and related training courses. Cybersecurity is a hot topic as supply chain risk emerges as a top concern in the energy sector. A cyber breach at any level in a supply chain has the potential to take down the whole operation.

Regulators in the North Sea are asking contractors detailed questions about OT Cybersecurity, especially on operations classified as critical infrastructure. This increased scrutiny has resulted in more detailed contractual requirements. Insurance companies are also looking for specific details before writing a cybersecurity policy.'

ISA has established a series of industrial cybersecurity standards that serve as your roadmap to improve security and protect your operations with strategies such as zero-trust architecture and OPC/protocols. Join us to learn more—register now!

### Keynote Speakers



**Megan Samford**  
VP, Chief Product  
Security Officer –  
Energy Management,  
Schneider Electric



**Cheri Caddy**  
Deputy Assistant  
National Cyber  
Director at ONCD/  
the White House

### TRAINING OPPORTUNITIES\*

#### 29 May

CyberSensors: Advancements in  
Automation CyberPhysical Security  
(IC87C)

#### 29–30 May:

Using the ISA/IEC 62443 Standards to  
Secure Your Control Systems (IC32)

#### 30 May

Cybersecurity Awareness Training for  
Industry Professionals (IC31C)

Cyber Incident Response (ICS4ICS)  
Workshop — *FREE with conference  
registration!*

### WHO SHOULD ATTEND?

- Automation Engineers
- Process Control Engineers
- Security Engineers
- QA Engineers
- Plant Engineers
- Manufacturing Engineers
- ICS Cybersecurity Engineers
- Digital Transformation Managers
- Engineering Manager
- Security Operations Center (SOC) Managers
- Compliance and Risk Managers
- Chief Information Officers (CIOs)
- Chief Information Security Officers (CISOs)

### INTERESTED IN SPONSORING?

View the prospectus at  
[isa.org/sponsor](http://isa.org/sponsor) or contact:

**Kim Belinsky:** +1 919-990-9404  
or [kbelinsky@isa.org](mailto:kbelinsky@isa.org)

**Morgan Foor:** +1 919-990-9267  
or [mfoor@isa.org](mailto:mfoor@isa.org)

**Register Now**





## Keeping Up on Industry 4.0? Follow the Influencers

By Renee Bassett, *InTech* Chief Editor

The term “Industry 4.0” is both a guiding light and an enigma. No universally accepted or agreed upon definition exists, and it has taken on different meanings since it was introduced in Germany in 2011. It is the name given to the Fourth Industrial Revolution—this current time in which fundamental shifts are occurring in the ways industrial companies operate and automation professionals contribute. Industry 4.0 encompasses new, rapidly evolving technologies such as data analytics, artificial intelligence, the industrial Internet of Things (IIoT), digital twins and more. And it offers a wide range of opportunities, benefits, and challenges for those in the midst of digital transformations and control system modernizations—the theme of this April issue.

Where does one go to get guidance and advice on making the most of Industry 4.0 concepts and technologies? This *InTech* digital magazine is a fine resource but may not be enough. Automation.com’s AUTOMATION 2023 ebooks and newsletters contain additional insights. A new [list](#) of the Top Industry 4.0 Influencers on social media (primarily LinkedIn and Twitter) contains 50 intelligent and prolific experts to follow.

Three of those influencers are members of ISA’s own Smart Manufacturing and IIoT

(SMIIoT) division—itself a rich source of best practices and insightful discussions. SMIIoT division members created the [August 2022](#) issue of *InTech*, which focused exclusively on Industry 4.0 concepts and technologies.

#1 on the list is [Jeff Winter](#). He’s an Industry 4.0 and digital transformation enthusiast who spearheaded the creation of the August 2022 issue. In it he wrote the feature “The Birth of Industry 4.0 and Smart Manufacturing.”

Author and thought leader [Mike Nager](#) is #21. He demystifies the world of smart manufacturing for educators and public officials with workshops, books, and lectures. He wrote *Smart Manufacturing Terms You Need to Know!*, a book for industry professionals, as well as *All About Smart Manufacturing*, which is a picture book for children.

[Ryan Treece](#), #37, serves as Tech Committee Chair – Edge & Cloud with ISA. He is a business development manager in IIoT at Telit and an *InTech* author.

“Digital transformation can be thought of as the journey and strategy to get to the vision of Industry 4.0,” says Winter. Every journey of transformation and modernization needs maps and guides. Through all the resources of ISA, may you find yours.

Where power is hard to find,  
Tadiran has the solution.



Don't let the cost and inconvenience of hard-wired AC power send you up a tree. Instead, be as remote as you want to be with the ONLY lithium cells to offer PROVEN 40-year service life without recharging or replacing the battery. When it comes to wireless power solutions, Tadiran is taking innovation to extremes.



 **TADIRAN  
BATTERIES**

\* Tadiran LiSOCL<sub>2</sub> batteries feature the lowest annual self-discharge rate of any competitive battery, less than 1% per year, enabling these batteries to operate over 40 years depending on device operating usage. However, this is not an expressed or implied warranty, as each application differs in terms of annual energy consumption and/or operating environment.

PROVEN  
**40**  
YEAR  
OPERATING  
LIFE\*

Tadiran Batteries  
2001 Marcus Ave.  
Suite 125E  
Lake Success,  
NY 11042  
1-800-537-1368  
516-621-4980

[www.tadiranbat.com](http://www.tadiranbat.com)

# Wireless Devices Drive Energy Optimization

By Jim Cahill

Companies across the globe are putting a strategic focus on environmental, social, and governance (ESG) goals to drive improvements in sustainability. On the environmental side, manufacturers and producers emphasize energy consumption and emissions reductions.

While energy efficiency has long been a key performance indicator (KPI) for these businesses, energy optimization has been limited by the available measurements and human resources to focus on such strategies. One reason for the measurement limitations is that most plants were instrumented just enough to provide basic control and safety functions, but not enough to maximize energy efficiency. And even if the available instruments produced sufficient data, organizational bandwidth means day-to-day operations and maintenance tasks take priority. Time-consuming activities, such as operator rounds, must be performed manually without continuous measurements and monitoring.

Many current energy management systems rely on manually collected data. Standard

operating procedures often specify that these measurements be read monthly, quarterly, or even yearly, with the readings reported and manually entered into the system. These instruments often track water, electricity, and fuel consumption.

## From data to actionable information

What has changed is the availability and breadth of wireless devices to easily add measurements and operational analytics to distill this wealth of additional data into actionable information for the plant staff.

Digital transformation is about using this actionable information to do things differently and better. For example, by using acoustic measurement technology to “listen” for leaks in steam traps, problems can be identified sooner and fixed to reduce wasted energy. This change is a transformation from quarterly, semi-annual, or annual manual inspections.

Another source of wasted energy is mechanical problems with rotating equipment, such as pumps, compressors, and fans. Equipping this machinery with wireless



**One reason for the measurement limitations is that most plants were instrumented just enough to provide basic control and safety functions, but not enough to maximize energy efficiency.**

vibration, temperature, and lube system sensors, and feeding these measurements into built-for-purpose operational analytics can provide the operations and maintenance staff with predictive early warning before mechanical problems develop and excessive energy is consumed.

Combustion is a significant source of energy consumption in many manufacturing processes, especially where multiple fuel sources are used. Traditionally, fuel/air curves have been used in control strategies. Additional measurements to get real-time BTU or kilojoule energy content in the fuel enable more advanced control strategies to efficiently set the air and fuel mixture to maximize combustion efficiency and minimize emissions.

Filters are used in many areas of production processes. Adding wireless differential pressure (DP) sensors across the filter can help with spotting early fouling that can reduce efficiency and increase the energy consumption of the process.

Another example is a heat exchanger, which can benefit from wireless monitoring. A fouled heat exchanger can cause what is being produced not to be heated sufficiently, requiring a burner to be fired to make up the extra heat, thus increasing fuel gas

consumption. A fouled heat exchanger may need more steam to heat the product or more chilled water or cooling water to be pumped to cool the product. Instrumenting the heat exchangers with wireless, non-intrusive temperature sensors on both hot and cold side inlets and outlets, and adding DP measurements combined with feeding this data to analytics software can help determine the optimum time for cleaning to minimize energy loss and scheduled downtime.

### Looking ahead

These are just a few examples where measurements can be easily added with wireless communications technology feeding built-for-purpose operational analytics software. This provides actionable information that plant staff can use to reduce energy consumption and improve operational performance.

It's essential to start with the business objectives when developing the path forward to more sustainable operations. Assess current performance, identify performance improvement opportunities, and prioritize projects to gain early successes and momentum to do more. The performance benefits come from lower energy consumption and emissions, and greater staff productivity from eliminating manual tasks.



#### ABOUT THE AUTHOR

**Jim Cahill** is a 30+ year veteran in the automation industry. He has an electrical engineering degree from the University of Texas with experience in offshore oil & gas production. He now leads Emerson's social marketing practice to promote [Emerson](#) automation technologies and expertise. Follow him through [LinkedIn.com/in/JimCahill](https://www.linkedin.com/in/JimCahill) or [Emerson Automation Experts](#).



# THE PROVEN DCS MODERNIZATION PROCESS.

**50+ MIGRATIONS PER YEAR ACROSS  
VIRTUALLY ALL INDUSTRIES AND PLATFORMS.**

**Our platform independence allows us to design  
and deliver the DCS solution that is right for you.**

The right system, implemented through the best process. The most talented team of experts ensures that your operations become safer, more efficient, more reliable, easier to maintain and easier to use.

**M<sup>▲</sup>VERICK<sup>™</sup>**  
TECHNOLOGIES

A Rockwell Automation Company

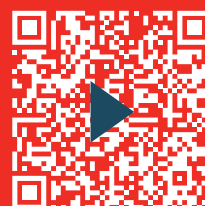

Learn more about  
our DCSNext solution

[mavtechglobal.com/dcsnext](http://mavtechglobal.com/dcsnext)

888.917.9109

# How DCS Migration Improves Operator Experience

Operators can see, hear, and feel the effects of modern distributed control systems.

By Scott Hayes and Fekri Abdullah

Migrating from a legacy control system to a new modern distributed control system (DCS) is a big job. For most of the people involved—operators, plant engineers, instrument techs, and other personnel—it may be a once in a lifetime project.

A migration provides many benefits that will help improve the lives of those involved in several areas of the plant floor. The maintenance technicians won't be chasing rare spare parts on the gray market. The plant manager will have remote access capabilities to monitor the plant operations from the office (or beach condo) on the new system.

With a project of this magnitude, the biggest impact is on the folks that use the DCS to run the plant—the operators. They need to understand the benefits specific to their area. Operators are often resistant to change and might be detractors from the outset, so convincing them might be challenging. If they still don't see the benefits after the migration is complete, the company has, unfortunately, failed in its business objectives. Success depends largely on upfront planning and getting buy-in from the operators and other key stakeholders.

Consider how a DCS migration can improve the operator's experience running the plant in three primary ways. To illustrate, think of the improvement process in terms of sight, sound, and feel.

- Sight is associated with the graphics—what operators see on the screen and how they get to the information they need.
- Sound is associated with the alarms—improving operator alarms and their situational awareness, as well as what operators react to during abnormal conditions and the action they are required to take.
- Feel is associated with process control—the way the DCS controls the system. How much of the control is automatic versus

requiring intervention? When do they have to intervene? Are they driving the bus, or is it driving them?

### High-performance graphics

Consider improving the sight—the graphics. By now, most people have heard of the [ANSI/ISA-101.01-2015](#), Human Machine Interfaces for Process Automation Systems standard and high-performance human-machine interface (HP-HMI) best practices, which equate good modern graphics to grayscale. This is a big part of improving what operators can easily see and respond to. Changing the color palette to a gray background with sparse use of color draws attention to abnormal situations and is part of the solution (Figure 1).

HP-HMI is more than just color changes, however. It's about planning. It's an evaluation of what needs to go on the Level 2 (L2) overview screens that an operator uses to run the plant.

When migrating legacy DCS graphics, replicating the screens that operators use is usually inefficient and doesn't improve their situation. Even though the operator has been used to the system's look and feel, it doesn't mean the user experience can't be improved. This is where the new HP-HMI best practices come into play: L1, L2, L3, and L4 screens should expose the right data and controls to reduce the operator's cognitive load and deliver the information needed, when it is needed.

Here are descriptions of what type of information is shown at each level:

- L1: Always up, wall-mounted trends or displays that are always visible. L1 gives

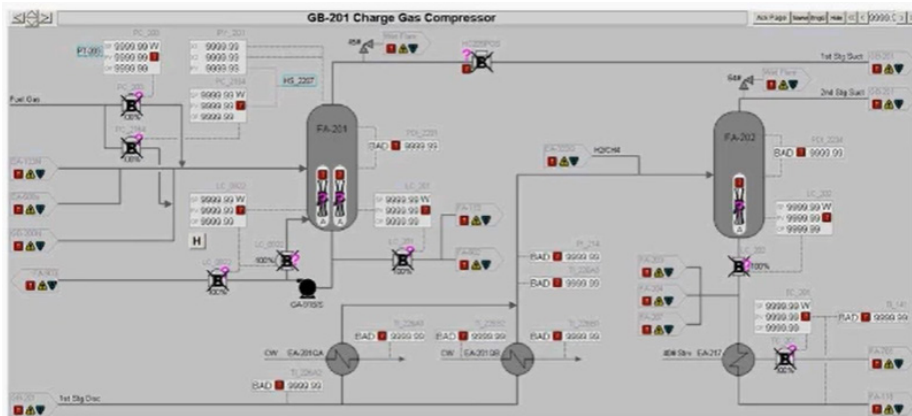

**Figure 1. High-performance HMIs following ISA-101 use grayscale graphics and sparse color to draw attention to abnormal situations.** Source: ISA/Maverick Technologies webinar, “[High Performance HMI Done Right](#)”

everyone a quick status of the unit or critical process data and how it is operating.

- L2: The money makers. These are the screens an operator uses to monitor the process and take routine action to make product.
- L3: Details. L3 provides more information on a particular process unit, which is required to diagnose, troubleshoot, or perform non-routine operations.
- L4: Pop ups. These are controls and faceplates that operators interact with until they go away.

Before moving from a legacy DCS system, best practice is to do an HP-HMI storyboard workshop. Get the engineers and operators together with an experienced facilitator to lay out the story of how the plant should be operated—not how it’s operated today, but how it should be run. The storyboard should include what information the operator needs to see at a glance and what can be hidden until needed.

The benefits of a storyboard workshop are twofold: The first is associated with the cost of the migration and the return on investment (ROI). A storyboard session can reduce the

number of graphics to migrate by as much as 40%. The cost of the session is quickly offset by the smaller number of graphics to migrate.

The second benefit is in the operation of the plant after the migration. With better access to information, the operators do a better job running the facility. The improved situational awareness allows them to recognize ways to improve the operation and head off potentially costly problems before they start.

## Alarms

Even with effective HP-HMI graphics, operators can’t see all things all the time. That’s what alarms are for, so improving the sound of the control system alarms is also important. [ANSI/ISA-18.2-2016](#), Management of Alarm Systems for the Process Industries, provides guidance from a standards perspective. A modern DCS has the capability to configure at least six or seven alarms on every input—highs, lows, bad signal, etc. The options are endless, but the operator’s bandwidth to filter and respond to these alarms is not.

The control system should only alarm the operator when an action is required. This takes



discipline and work. The remedy for this situation is well known. Alarm rationalization is needed to evaluate and document all the alarms and decide what is necessary and what can be eliminated, consolidated, or made smart.

One method for smart alarming is alarm shelving or disabling based on other plant conditions. For example, a low-flow alarm may be redundant if the pump providing that flow is not running. Alarm shelving is the capability to hide or remove multiple alarms based on a process condition. For example, if a compressor is taken out of service, the operator does not need to respond to any of its alarms. Shelving those alarms until the compressor is placed back in service can ease the load on the operator.

The payback for an alarm system that only rings when needed is twofold: First, it gives operators the ability to recognize abnormal situations quickly and act to mitigate them. After all, this is the purpose of an alarm system. Second, without nuisance alarms occurring constantly, operators have time to do their most important job—running the plant. It gives them the time and focus to improve yield and reduce errors.

### Process control

One of the most common improvements in a control system migration is loop tuning and mitigation. Since every loop must be reprogrammed, it is an excellent time to improve their tuning and control conditions. Undiagnosed problems or problems that have been ignored for years can be evaluated and corrected.

Another improvement to the feel of a control system can be the difference between operating an almost self-driving car and a backhoe. In a modern car with cruise control, lane detection, and safety features, we can guide the vehicle where we want it to go, but we don't have to control every action all the time. A backhoe, for example, requires the operator to directly manipulate every move with a separate joystick or knob. This method works, but it takes a lot of skill and manual control. Many legacy plants run that way.

**Even with effective HP-HMI graphics, operators can't see all things all the time; that's what alarms are for.**

One of the most promising methods that is increasingly becoming accepted is state-based control (SBC). In SBC, each unit or piece of equipment has a set of operating states (Figure 2).

For example, a distillation column may have idle, filling, heating, running, and total reflux as its set of states. Rather than manipulate valves and proportional-integral-derivative (PID) controls directly, operators can step the column through the states, or the control system can automatically move the column to a new state based on previously defined conditions. This allows the operator to spend more time setting the course, rather than driving the bus. Less time spent on easily

## Why Use State-Based Control?

### Intelligence can be built into the devices:

- Smart alarms
- Pumps, block valves, control valves

### Integrates startups and shutdowns:

- Units can easily talk to each other to move states based on what process conditions need
- Builds in operating procedure, including startup/restart
- Automatic equipment swapping
- Improved asset utilization, safety and reliability
- Increased time between outages

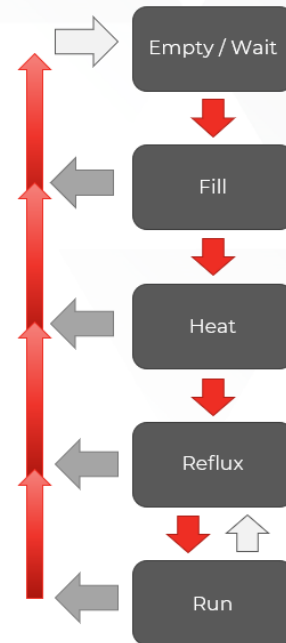

Figure 2. Advantages of state-based control. Source: Rockwell Automation

automated tasks gives the operator more time to run the plant.

States also can be used to enable or disable smart alarms when conditions make that alarm meaningless. If the column hasn't filled with liquid yet, the low-level alarm is meaningless.

Another method of increasing the control of the plant involves a step change in the control strategy. The expert implementation of advanced regulatory control techniques such as feed forward, ratio control, and inferred properties can have an impact on a plant's ability to operate closer to constraints and thereby increase throughput. Again, a DCS migration brings the right expertise together and touches every control strategy in the controller. There is no better time to at least consider the execution of these strategies.

## Final thoughts

A control system migration is a big endeavor and requires buy-in from key stakeholders across the enterprise. The re-creation of graphics and control strategies on a new system is a challenging task, but it is also a great opportunity to improve the operator experience and overall production processes. Careful planning and some upfront work can improve the operator's control of a plant in three key ways: sight—improving the graphic layout for the operator, sound—improving the alarm system, and feel—improving the operator's control of the process.

All these improvements eliminate distractions and allow the operator to focus on the real job—to keep production processes and the plant up and running. The ROI that these improvements provide can pay out big and help companies maintain their competitive edge.



**ABOUT THE AUTHOR**

**Scott Hayes** is the DCSNext portfolio manager at [Rockwell Automation](#). Hayes is a licensed control system engineer with more than 20 years of experience leading automation projects and programs, as well as hands-on configuring and networking of DCS, PLC, HMI, process historian, and visualization solutions.



**Fekri Abdullah** ([fekri.abdullah@mavtechglobal.com](mailto:fekri.abdullah@mavtechglobal.com)) is a senior engineer at [Maverick Technologies](#), a Rockwell Automation Company. Abdullah has a bachelor's degree in electrical engineering from the University of Michigan Dearborn. He has been working with MAVERICK in the automation field for more than 14 years, supporting numerous projects in different processes and platforms.



**NEXTGEN INCREMENTAL ENCODERS**



**Meet POSITAL's New Generation of Encoders**

New sensor technology and upgraded processors offer better performance with lower energy consumption.

Programmable for more flexibility: Resolution and communications interfaces can be customized to meet your exact requirements.

Available as drop-in replacements for encoders from most major manufacturers.

More NeXtGen product announcements coming soon!

[www.posital.com](http://www.posital.com)

# THE EDGE OF INNOVATION.



Edge devices are transforming the way we connect and control our world. With a library of over 140 Ethernet and Serial protocols, MSA FieldServer offers universal access to your vital controls and device data. Exchange information, push out alarms, capture historical data, make calculations, and feed your IoT applications. All in a compact platform that meets stringent cybersecurity requirements and has no OS to maintain. Experience the power of edge computing today. Learn more at [msasafety.com/fieldserver](https://msasafety.com/fieldserver).

**MSA**  
The Safety Company

# Modern Tools Create Modern Systems

By Aaron Crews



## AI- and cloud-based engineering tools accelerate control system modernization efforts.

Artificial intelligence (AI) and machine learning (ML) technologies are having a moment right now, and many manufacturers are eager to transform their infrastructure to apply these types of technologies to improve

operations. But applying these technologies requires a modern infrastructure, and reaching this goal is fraught with complexities. This begs the question: “Can we apply AI and ML to ease the modernization process itself?”



The answer is yes. End users can apply AI and ML technology to projects to reduce cost, mitigate risks, and accelerate schedules. The result is expedited delivery of modern tools to manufacturing operations, enabling new insights and transformative business practices.

### Operational challenges

Today's process manufacturers face a more complex environment than ever before. Operating in a global marketplace, they are being forced to compete within an ever-expanding arena. Staying effective means operating reliably, safely, and efficiently by employing technologies that create more flexible manufacturing environments to deal with changing customer needs, supply chain disruptions, and personnel shortages.

Unfortunately, many of those same manufacturers are still using control technologies that are 20, 30, or even 40 years old. Not only are these legacy systems typically complex and difficult to operate, but they often require specialized expertise and parts to keep them running, leading to extended outages and expensive repairs. Also, these problems will only get worse in the future as automation suppliers discontinue support for legacy systems, and as the few remaining personnel with specialized experience in these systems retire.

The most obvious solution to aging technology in the plant is control system modernization, but modernization projects can seem overwhelming. Plants that have been operating for decades often have many instances of custom automation that are

critical to running the plant properly. Without a deep bench of expert personnel, reengineering all that automation to function under a new control system appears to be a daunting task. It creates the fear that a new system might not operate as efficiently or effectively as the old system because something was not converted correctly.

The typical response has been to wait. Process manufacturers want to implement new, modern technologies, but they also need to avoid harming or disrupting the way the plant operates. Project teams often do not have the resources—people, tools, budgets, and insights—to redo their automation from scratch, but they also do not want to invest in an upgrade that does the same thing they were already doing. Ultimately, they feel stuck. But that paradigm is changing.

### Benefits of modern control

Today's digital technologies offer benefits that operations teams hoping to stay competitive cannot ignore, and digital modernization technologies are making them easier to implement than ever before (Figure 1).

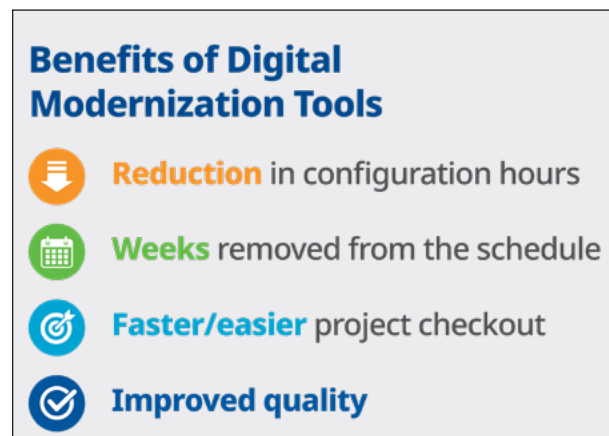

Figure 1: Digital modernization tools offer many advantages over traditional tools.

Highly efficient and competitive modern process control plants look very different from plants of just 10 years ago. Helpful process technologies that were unavailable or very expensive many years ago are considered best practices today. Some are critical to meeting regulations, while others keep a plant operating at peak efficiency. One example is pervasive sensing technologies.

The cost of sensors has fallen dramatically in recent years, just as experienced personnel—those who can look at an asset and quickly identify problems—are leaving the workforce in droves. As a result, plants are adding sensors to many more assets to increase performance and safety visibility, helping operators do their jobs better through automated decision support. Today's sensors provide easy-to-understand data, comprehensible by even the least experienced operators. The best automation suppliers have made it intuitive to integrate that data into the control system, helping foster better awareness and control.

or firing of burners. Alarm applications are designed to integrate with modern control systems to improve visibility and simplify customization of alarm content based on process state. These technologies can also be coupled with advanced process control, which enables plants to build best-practice control strategies into automation to ensure that they are repeated the same way every time.

### Project design and engineering challenges

Plants operating legacy control systems are typically unable to take advantage of these and other modern technologies—unless money is spent to construct complex, fragile custom engineering to connect the systems. Such solutions typically increase the cost of support and the need for expert personnel, who are already difficult to find. The better solution is to modernize the plant, implementing a new control system built from the ground up to support today's essential automation features. But traditional methods face many hurdles.

**The way to reduce the risk associated with modernization projects is to shift away from traditional project engineering and instead embrace digital technologies.**



Many plants are also using advanced industrial software to manage alarms, both to automatically reduce alarm floods and to improve safety when executing abnormal process steps, such as startup and shutdown,

The first hurdle to modernization is managing the project design and engineering. Upwards of 50 percent of any modernization project is engineering work, and that work traditionally requires many experienced

personnel and many hours of time-consuming design, checks, and rechecks.

When engineers develop and use tools for modernization projects, those tools are typically project-based and not reused. Every project is a little different from the one that preceded it, and it is designed around the knowledge of the engineer who programmed the tools—a person who may no longer be available. That means each project is typically self-contained; it is planned, designed, and documented from the ground up.

The engineering company involved typically uses a tool to pull the data from the legacy control system into a database. Each engineer has a tool they like, and each tool has its own pros and cons, and associated bugs.

After the legacy data is moved, engineers go through the database and manually assign every function block and piece of code to a template, and they then develop custom queries around those templates. Again, the process is manual. After the templating step, engineers create new tables and design append queries to translate the legacy code to the code for the new control system, then use the text files generated from that process to develop a format specification file that is used to create new code.

In this traditional manner, each stage of the engineering process is manual. Not only is this manual work time-consuming, but there are numerous opportunities for mistakes everywhere along the path. This leaves project teams with two choices, neither of them ideal. They can either spend a lot of

time double-checking the process and fixing errors as they come up, or they can leave the debugging until the end of the process when it is on the critical path and fix them then. In either case, the time spent double- and triple-checking, and then fixing mistakes is zero value-add.

Also, in many cases, this process is performed via email, with days or weeks of waiting between each step. When mistakes are discovered, those mistakes not only add to the time needed to fix the problems, but also add more waiting time as engineers transfer data back and forth.

The engineering stage is complex, and traditional modernization strategies are challenging. So, with limited budgets and personnel, many project teams opt for “replacement in kind”—the most low-risk option for modernization. But this often leaves the operations team with an automation system lacking the performance improvements available with modern technology and can limit the team’s ability to take advantage of those technologies in the future.

## Digital technologies for project engineering

The way to reduce the risk associated with modernization projects is to shift away from traditional project engineering and instead embrace modern solutions based in digital technologies. Today’s automation providers are creating tools to digitalize the project engineering stage of modernization.

Digital tools dramatically reduce the time spent engineering while simultaneously



eliminating much of the potential for errors and enabling best practices to drive improved plant performance. Now, instead of simple conversion tools to update controls, teams are looking to comprehensive smart tools to identify functions and automatically replace them with modern implementations in a new system.

The top automation providers in the world execute multiple modernization projects every day. Their engineering teams then process the data from each of those hundreds of annual modernization projects in a central, cloud-native toolset. Using AI to automatically leverage the organization's past project experience, engineers structure the data and separate it into its core functions while identifying complex control strategies and areas for improvement. That means, instead of using a

conversion tool that has been used on one or two projects, today's end user project teams can work with their automation provider to train centralized machine learning tools with data from hundreds or thousands of projects.

The AI digs through the legacy code and identifies functions that are part of the tool's past project experience. If the AI sees something repeated that matches work performed on previous projects, it extracts that code and structures it to transfer over to the new control system. Not only is the code automatically converted, but it uses a best-practice structure for the new control system that is automatically documented to create a powerful automation foundation. Because the process is automated, the project team does not need to worry about errors in the code (Figure 2).

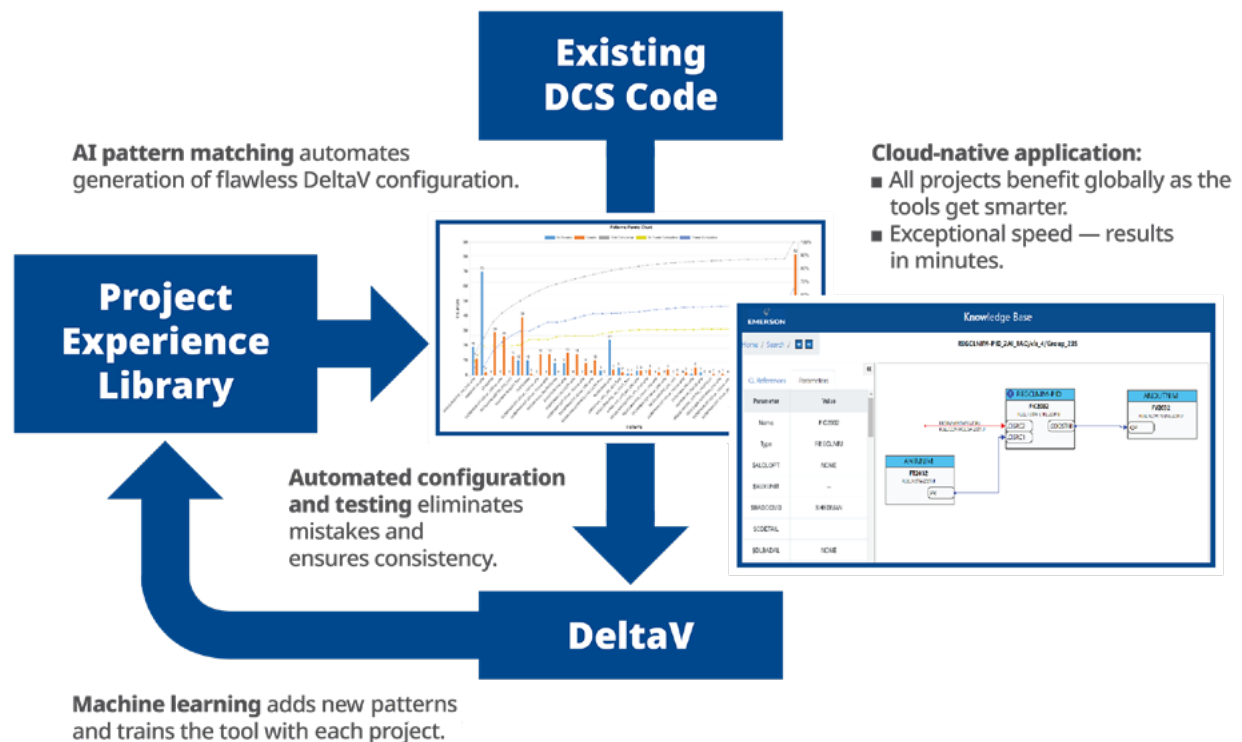

Figure 2: Modern technologies like Emerson's ReVamp and IO.CONNECT leverage artificial intelligence and machine learning to simplify, streamline, and enhance modernization projects.

## DIGITAL TRANSFORMATION

In some cases, the AI will find code or other content that isn't recognized. In these instances, the tool not only automatically generates logic drawings, but also uses an ML algorithm to identify clusters of repeated control strategies as candidates to add to the library. When the tool has enough instances of that code, engineers can review and promote those strategies to the library. As a result, the tool continues to get smarter with each project, continually adding new designs and best practices.

This process ensures that every modernization is the best modernization because the tools are continually improved over an ever-growing number of projects. And, because those tools are cloud-native, they are constantly updated, ensuring that teams are always engineering their projects with the highest possible accuracy and efficiency.

## Better mapping with metrics

New digital modernization tools also help project teams better plan the execution of their projects, well before engineering begins. Digital modernization project tools scan legacy control system code and generate a comprehensive project report. The report helps project teams see how much of their existing code conversion has the potential to be automated, how much must be built by hand, and how much will require reengineering (Figure 3).

These metrics not only help the team budget and slice the project into reasonable phases but also help remove late-stage surprises and change orders. Traditionally, teams made a lot of assumptions about each project in the design phase, but when they were

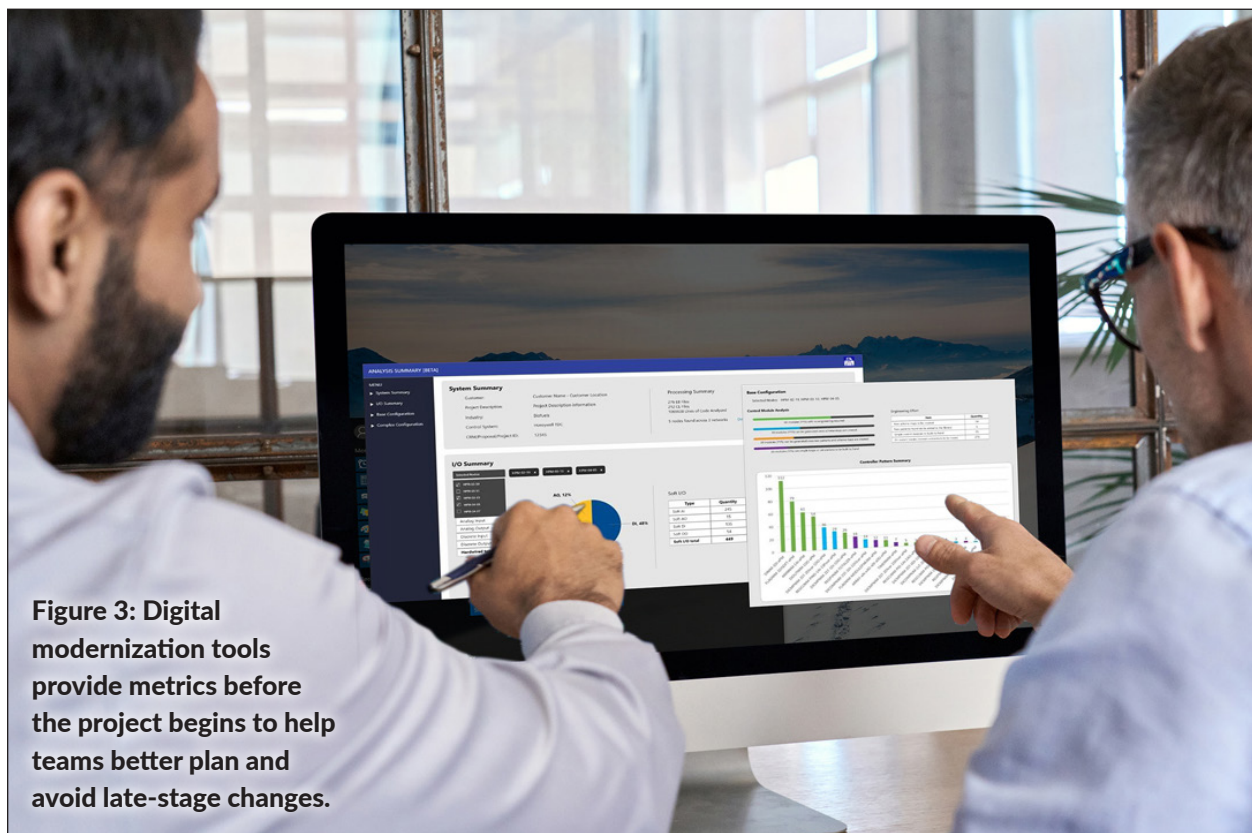

**Figure 3: Digital modernization tools provide metrics before the project begins to help teams better plan and avoid late-stage changes.**

wrong, the automation engineering partner would need to issue change orders. This led to some teams carrying too much contingency in the budget, and others not carrying enough. With the metrics available in digital toolsets, however, teams have a much better idea of what needs to be done from the very beginning of project execution, dramatically reducing costly changes, and the need to carry budget overages to plan for them.

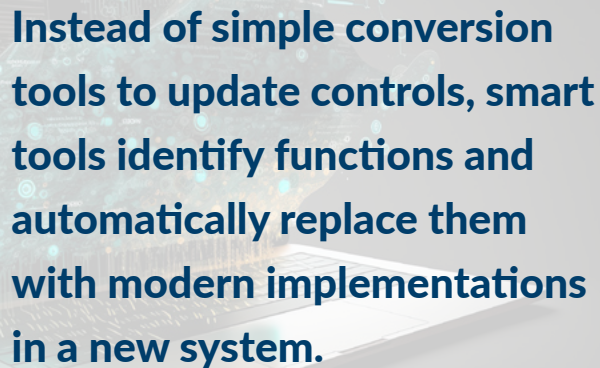

**Instead of simple conversion tools to update controls, smart tools identify functions and automatically replace them with modern implementations in a new system.**

### **Faster and foundational**

Digital modernization toolsets are also faster than the traditional conversion tools of the past. Instead of emailing files back and forth, teams simply upload data into native cloud tools to take advantage of the increased processing power in the cloud. Results typically come in minutes rather than days. This fast turnaround helps teams ensure that they can get their basic automation foundation—built on engineering strategies that have been validated by world experts and used many times—completed early on in a modernization project.

Even more important, that foundation is built with more complex automation in mind.

The new automation is not just a conversion of what the plant had before. Instead, the team receives a functional reimplementa-tion of control logic in the new control system that also contains all the hooks needed to add on such advanced functionality as state-based control, advanced control, dynamic alarming, and optimization for abnormal operations—switching grades or startup and shutdown, for example. Teams no longer have to extensively reengineer to implement available new technologies when upgrading a control system.

As more teams use advanced moderniza-tion tools to drive better projects, they will also leverage the ability to store all the content from digital tools in a single cloud location. Project engineering teams at engineering companies and integrators will be able to collaborate with the automation vendor to take advantage of this experience, gain access to these tools, and access a central location to manage project libraries.

All information, such as engineering designs, documentation, and support, will be accessible via the cloud through a continuously updated digital platform. This complete repository will provide information that both engineering teams and their customers can use across the lifecycle of the modernized facility.

### **Easier, more accurate modernization**

Today's advanced cloud-based moderniza-tion tools drive increased value compared to traditional conversion tools. Not only do they dramatically speed the process of engineering

## DIGITAL TRANSFORMATION

a modernization project, but they do it with more visibility across the entire project while simultaneously eliminating errors. Teams spend less time testing project engineering steps and are not crunched for time at the end of the project the way they typically were in the past. Automating these tasks removes

countless hours of work and sets teams up to implement more complex automation strategies much earlier in the project, helping to ensure that they more easily accomplish the goals that put them on the path to modernization in the first place.

*All figures courtesy of Emerson*



### ABOUT THE AUTHOR

**Aaron Crews** is the global director of modernization at **Emerson**. He has extensive experience planning and executing control system modernization projects throughout the hydrocarbon value chain, and his current focus is on enabling approaches and technologies that deliver the value of modern automation at reduced cost and risk. Crews received a BS in chemical engineering from Texas A&M University and an MBA from The University of Texas.

## Introducing

### uOPC DataBridge

Enabling Seamless OT-IT Integration

- ▶ Utthunga's uOPC DataBridge is a Cloud & Enterprise-ready solution that consolidates access to multiple OT data sources while ensuring secure data passage across the DMZ & Firewalls during OT-IT Integration.
- ▶ Improve operational efficiency and visibility to OT data.
- ▶ Access to a wide range of OT data sources and protocols,
  - Modbus TCP/RTU
  - OPC-UA, DA, AE, AC
  - DNP3
  - BACnet
- ▶ Enables seamless data exchange and interface to IT & Enterprise Systems via
  - MQTT
  - AMQP
  - OPC-UA, DA
- ▶ Flexible Perpetual Licensing Models based on Per Instance, Per Site and One-time OEM Licensing for unrestricted usage.

[www.utthunga.com](http://www.utthunga.com)

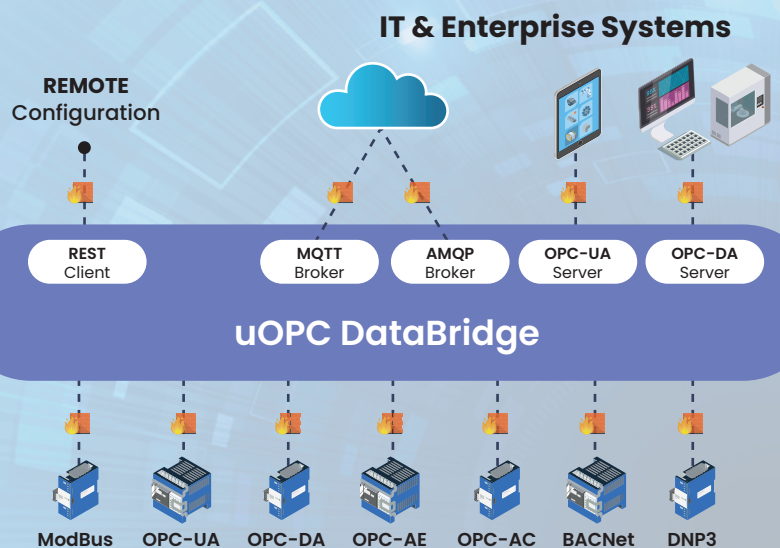

**Distributed OT Systems**  
Field Devices, Controllers, Systems

**FREE TRIAL** License Available

[contact@utthunga.com](mailto:contact@utthunga.com)

Utthunga Technologies Pvt. Ltd.  
Bangalore | Houston | Boston | Frankfurt | Tokyo



# INDUSTRIAL CONNECTIVITY MADE EASY

RTA is your go-to source for factory floor connectivity. Since 1989, we've partnered with OEMs, distributors, integrators and end-users all over the world, helping them overcome their industrial communications issues with easy-to-use connectivity products. We've continually developed our products to seamlessly integrate your process equipment so you can collect, analyze and interpret the real-time data you need to improve productivity and maximize efficiencies.

Simply put...we move your data.



### Industrial Protocol Gateways

Connectivity solutions to move your data where you want it and how you want it



### Software Solutions

Add protocols directly to your devices with royalty-free source code stacks



### Custom Solutions

We do it all: from simple coding projects to massive ground-up development

**DeviceNet**®

**EtherNet/IP**®

**Modbus**

**OPC UA**

**PROFI BUS**®

**PROFI NET**®

And many more!

Our products are made in the USA, always in stock, ready to ship and include expert support!

Contact us: [solutions@rtautomation.com](mailto:solutions@rtautomation.com) | 800.249.1612 | [www.rtautomation.com](http://www.rtautomation.com)

# PREPARE TO MODERNIZE YOUR PLANT

**Change is coming to process automation. Newer standards for connectivity favor the early adopters.**

**By Ted Masters and  
Paul Sereiko**

Change comes slowly in the process automation industry in general, particularly in process plants and facilities. Consumer product lifecycles are measured in durations as short as just a few months, and factory automation upgrades typically occur every few years to match their output to consumer demand, but a process plant often operates for decades.

Once a plant has begun operating, upgrades occur rarely, and typically only to meet a new requirement such as regulatory compliance or increased capacity. In general, the closer a piece of hardware is to the process, the more costly it is to upgrade.

Thus, instruments, valves, remote input/output (I/O), and other field devices often remain in place with little change for many years. For example, upgrading an instrument with a process penetration might require cutting and welding, in addition to new wiring infrastructure, making it a costly proposition.

This phenomenon in part explains why 4-20 mA instruments, often supporting the HART communication protocol, still dominate the installed base. But it doesn't explain why even today, 4-20 mA HART instrument devices still represent the greatest market share for new instrument shipments.



## CONNECTIVITY

A leading reason may be that until a technology enters the market that meets the needs for both real-time control—for example by providing operational simplicity—and the asset management and maintenance teams’ desire for data, 4-20 mA plus HART is often the best option. But end users would do well to select vendors and automation system components with the future in mind. This requires understanding the progress being made toward adoption of multiple industry standards and frameworks for system development, connectivity, and communications. These and other changes also necessitate a closer bond between operational technology (OT) and information technology (IT).

In response to this need, government, user, and standards development organizations

(SDOs) like FieldComm Group are active in many of these areas. FieldComm Group, for example, co-owns the Ethernet-APL, Field Device Integration (FDI), and Process Automation Device Information Model (PA-DIM) standards with other SDOs.

The “advanced physical layer” of Ethernet-APL promises to bring high-speed, IP-enabled communications to the instrument and infrastructure network layers. Remote I/O will be replaced or augmented with Ethernet switches in many cases, and 4-20 mA field devices will be upgraded to their Ethernet-APL counterparts. Ethernet-APL field devices will be connected through Ethernet switches to controllers, human-machine interfaces (HMIs), servers, and other hosts as part of the greater automation system. (Figure 1).

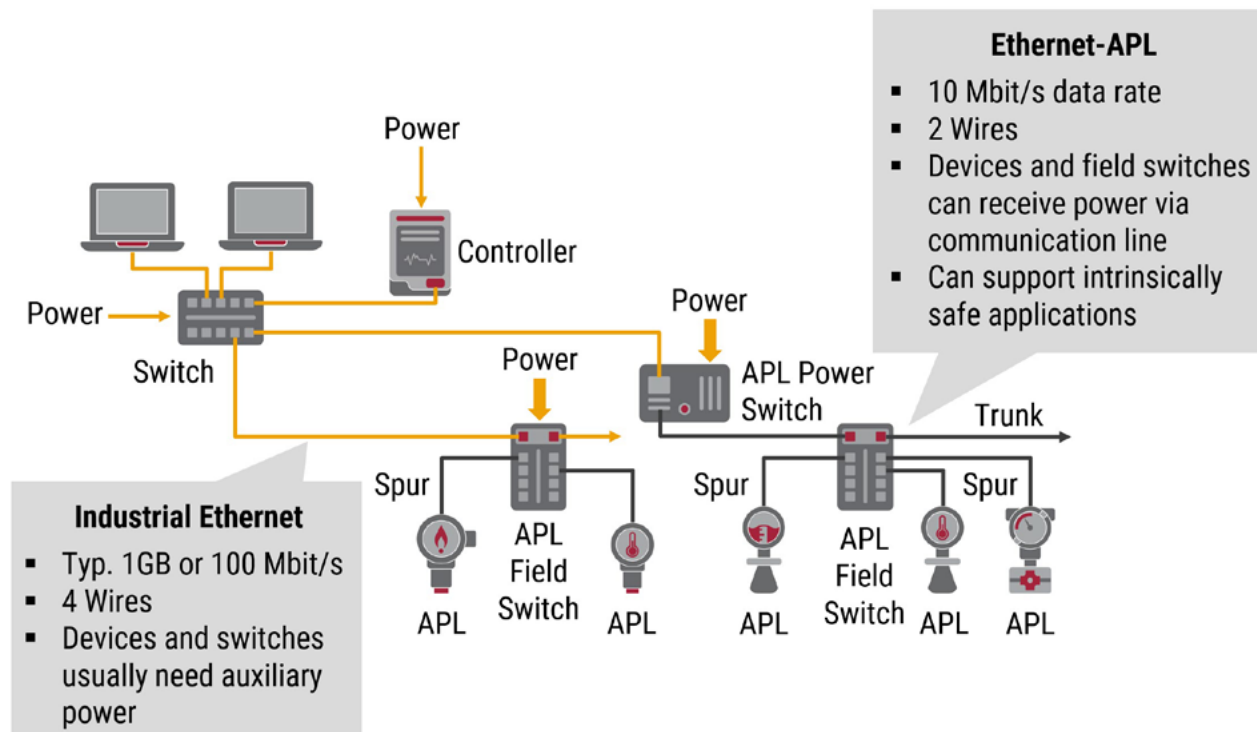

Figure 1: Ethernet-APL field devices will connect to Ethernet switches, which in turn will connect to controllers and servers.

For large process plants, hosts often include an asset management system and a distributed control system (DCS). The DCS landscape is also facing significant change, as the Open Process Automation Forum (OPAF) aims to re-invent the controller and DCS business with an open architecture solution, removing end user reliance on proprietary vendor technology.

Widespread adoption of these initiatives will create a much higher degree of interoperability, allowing end users to pick the best-of-breed products for their applications. It will also force vendors to innovate on product features and benefits demanded by end users, instead of focusing on the development of proprietary technologies.

SDOs, and many end users, in the process automation industry are optimistic that the previously described initiatives will result in improved plant operations in the future. Vendor support varies, with some strongly supporting all initiatives and others targeting their support based on the perceived strengths of their product portfolios. End users should eventually see more open systems, and this transition can be hastened if they have a plan in place to adopt these new technologies.

### Step 1: Plan and prepare

**Hardware considerations.** Most of the installed field device base is 4-20 mA, often with HART, and current shipments are still largely 4-20 mA, albeit with even more HART-enabled devices. But it should be clear that if a facility wants to be able to take full advantage of open systems and digitalization at any reasonable scale, it needs to start laying the foundation now for what will eventually become a modernized plant.

From a physical perspective, plant personnel should initially identify high-value assets and processes that might be targeted for future digitalization, using one of two methods:

- **HART-IP gateways.** 4-20 mA HART field devices often terminate at a host system that does not support the HART standard. To address this issue, several vendors offer gateway products that can capture data from multiple HART instruments, buffer the information, and then publish it over high-speed wired Ethernet using the HART-IP protocol for use by host systems.
- **WirelessHART.** Virtually any 4-20 mA HART instrument can be converted to support *WirelessHART* with the addition

**Identify high-value assets and processes that might benefit from digitalization and lay the foundation for physical modernization by using either HART-IP gateways or *WirelessHART*.**



## CONNECTIVITY

of an adapter, available from many vendors. The upgraded instrument can then be connected to a *WirelessHART* network, and eventually to a host system via an Ethernet connection from a *WirelessHART* gateway. The existing 4-20 mA connection can be maintained for real-time control, with the wireless system freeing up formerly stranded data, such as secondary process variables and diagnostics, for use by host systems (Figure 2).

It's also worthwhile to assess which units might be undergoing a turnaround in the near

term. If updated wiring infrastructure is part of the plan, users should consider selecting cables and routings that will work with future installations of Ethernet-APL devices and switches.

**Software considerations.** On the software side, adoption of host systems supporting modern communication technologies should be considered, as these will be required for implementing plant modernization and digitalization strategies. FDI technology, which is endorsed by end user organizations like NAMUR, has been available for several

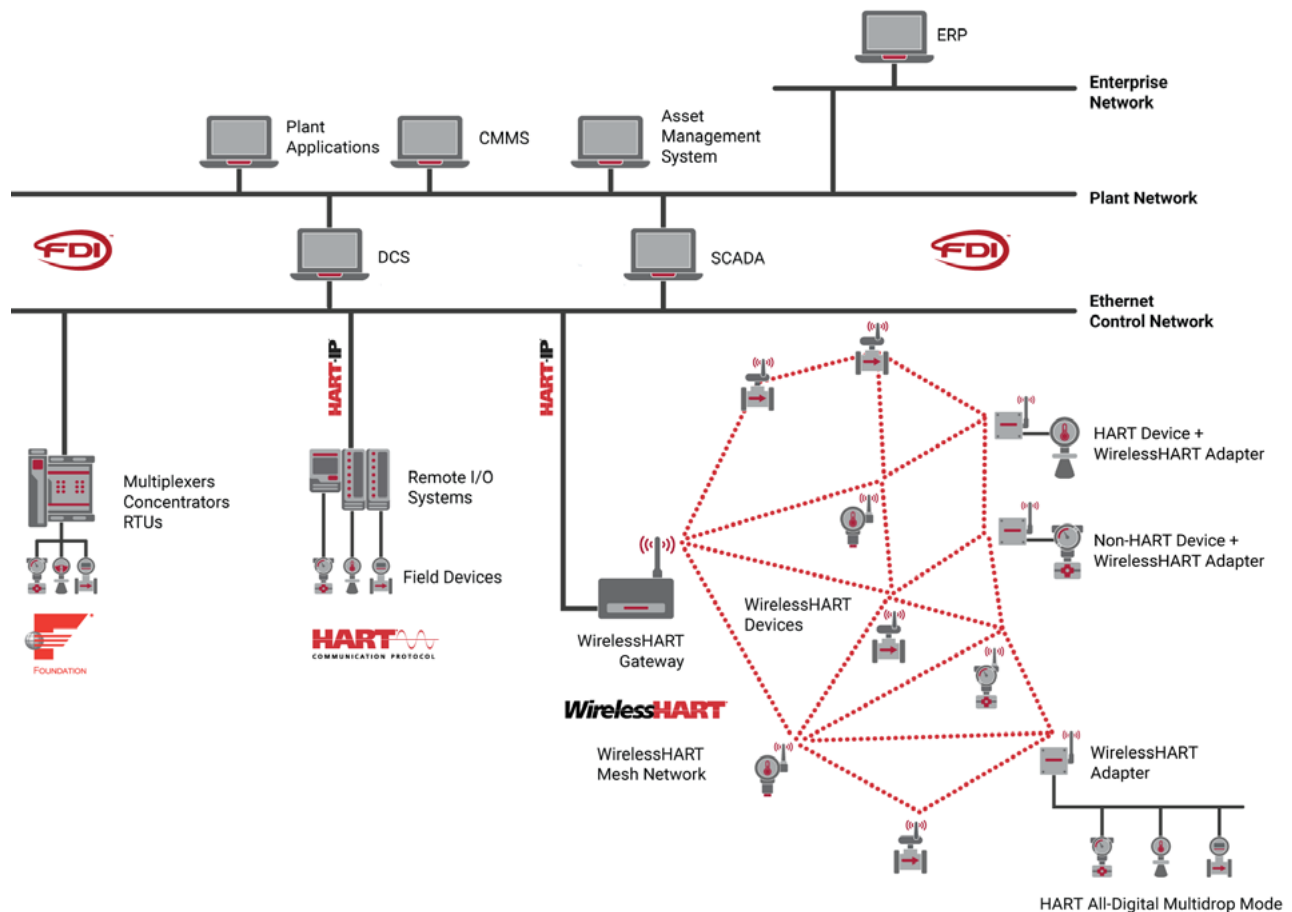
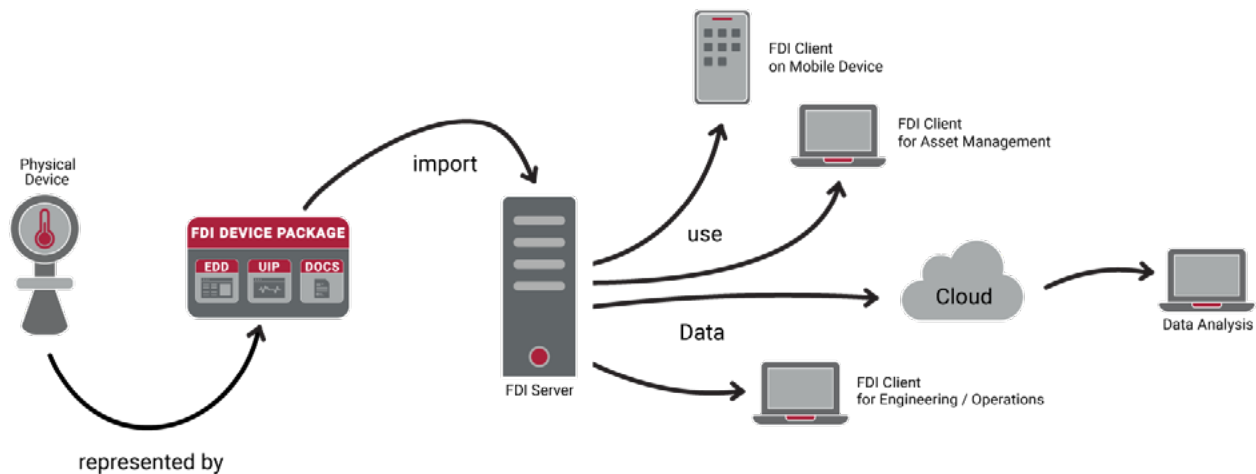

Figure 2: *WirelessHART* adapters can be used to free stranded data from 4-20mA HART instruments, and to connect non-HART 4-20mA instruments to *WirelessHART* networks.



**Figure 3: FDI supports communication with many different clients, including asset management systems, with compatibility assured by testing provided by the FieldComm Group.**

years, and most major host system suppliers support it (Figure 3).

One of the key benefits of FDI is simpler device integration with host systems, but the FDI host architecture also enables additional integration, including host-to-cloud connectivity, for example using OPC UA technology and the PA-DIM information model.

FDI implementation requires both host system and field device support. First, host system software must be FDI-enabled, so end users should seek out FDI-registered host software, available from ABB, Emerson, Honeywell, Siemens, and other vendors. Second, instruments must support the FDI device package, which is similar to a ZIP file. When imported into an FDI host, the package expands to include a driver file for the device, as well as additional files like documents and user interface plugins.

FDI device package technology now supports many features that end users

have demanded in an integration solution, including:

- **Device health:** Advanced device health diagnostics must be supported per the NAMUR NE 107 recommendation.
- **IIoT readiness:** Support for PA-DIM
- **Offline configuration:** Standardized support for bulk configuration of instruments and systems prior to installation
- **Modern user interfaces:** FDI device packages from some vendors may come with a vastly improved user interface plug-in (UIP), supporting .NET or HTML5 technology.
- **FDI device package security:** The FDI device package ensures security because vendors and test organizations, like the FieldComm Group, must “sign” the package using a recognized certificate authority during the conformance and registration process. Once these building blocks are in place, the next step can be taken—piloting new technologies.

## Step 2: Pilot new technologies

Ethernet-APL networks will fundamentally alter the design of future process automation systems. But first, they will begin to displace existing field networks that use cabling common to FOUNDATION Fieldbus and Profibus-PA, or they will be used in unit turnarounds where instrumentation and infrastructure are being replaced.

One of the key features of Ethernet-APL is the separation of the physical layer from the automation protocol, heretofore linked. This separation allows for installation of a plant-wide Ethernet infrastructure that can then be used with much greater flexibility.

**Ethernet-APL networks will fundamentally alter the design of future process automation systems. But first, they will begin to displace existing field networks.**

Since most core process instrumentation is used to measure pressure, temperature, level, and flow—and since most of these instruments currently use 4-20 mA plus HART communications—it often makes sense to pilot versions of these instruments with native HART-IP support. This protocol extends the HART feature set with security and direct real-time control, and it can be architected on any Ethernet media. But most important, since almost all of

the installed base supports HART technology today, the transition of workforce and workflows to HART-IP will be significantly less invasive than adopting a new automation protocol. Having a flexible networking infrastructure will also allow the use of other protocols, perhaps PROFINET for motor controllers, EtherNet/IP for analytical instruments, and eventually the OPC UA native devices currently being specified in the OPC UA FX project.

While a complete portfolio of Ethernet-APL-enabled instruments of the type used in process plants is still a few years away, Ethernet-APL products are now starting to become available in the market. For example, Pepperl+Fuchs offers a FieldComm Group-registered Ethernet-APL field switch. Several instruments supporting PROFINET, which can be used with an Ethernet-APL network, will become available in mid-2023.

Therefore, it makes sense to start piloting Ethernet-APL soon, for several reasons:

1. An Ethernet-APL network will provide much more data to the plant and the enterprise. Understanding how much data, where that data is needed, and what to do with it should be an objective of any pilot installation.
2. Ethernet-APL is just an Ethernet physical layer. Like any Ethernet network, it needs to be monitored and controlled for security access, and potentially traffic management. But unlike traditional Ethernet networks, Ethernet-APL switches and instruments will often be deployed in hazardous areas. Understanding how work processes will change with Ethernet-APL installations can be assessed and finalized during a pilot.

3. Ethernet-APL instruments might operate differently than current 4-20 mA or fieldbus devices. Specifically, high-speed communications will enable more efficient access to the instrument, along with greater ability to directly manage and configure it. Again, understanding how workflows might change as Ethernet-APL devices are deployed is an important consideration for a pilot.

While piloting a high-speed Ethernet-APL infrastructure, end users should also consider piloting associated applications for monitoring and optimization (M+O), as recommended by [NAMUR NE175](#). These applications are deployed outside the core process control domain and have extremely limited ability to impact the process. Therefore, things like firewalls, data diodes, and other security measures will be needed.

Once that infrastructure is in place, data from that fast Ethernet-APL network can be

captured and processed by the M+O applications, such as an asset management system. In this domain, technologies built on OPC UA information modeling techniques can help “cleanse” the data by eliminating protocol dependencies and adding semantic identifiers. The PA-DIM information model is an OPC UA information model that is supported in FDI device packages, and it is thus a good choice for these types of applications. Piloting a PA-DIM-based web application targeted at implementing some of the use cases of the NAMUR Open Architecture now can pay dividends later.

Change is coming to the process automation industry, and end users should start laying the groundwork now so they can be ready to quickly adopt new technologies as they become more widely available. This will allow them to reap benefits in short order, gaining an edge on their less prepared competitors.

*All figures courtesy of FieldComm Group*



### ABOUT THE AUTHOR

**Ted Masters** is the president and CEO of the [FieldComm Group](#). He has held leadership roles in a wide variety of technology companies supporting the process industry for more than 30 years. Masters has experience in managing the growth and delivery of products, software, and service solutions to industrial markets. His career has been centered on the conversion of operational data into actionable intelligence and helping users make better decisions to capture the value by integration into business systems and processes. Masters has a BSEE degree from the University of Kentucky.



**Paul Sereiko** is the director of marketing and product strategy of the [FieldComm Group](#). He is responsible for guiding worldwide marketing efforts to increase the adoption of FieldComm Group digital automation technologies and solutions in plant environments across the world. Sereiko has a BS in computer engineering from the University of Illinois and an MBA in marketing and finance from Northwestern University's Kellogg Graduate School of Management.

# Industrial Cybersecurity is a Global Imperative

It's time to join forces. We are stronger together.

**Get Engaged!**

[Follow our blog](#)

[Download our white papers and guides](#)

[Join the End User Council](#)



# Field-Level Comms Improve IIoT Implementations

Start incrementally at the edge by combining proven fieldbuses and controllers.

By Bill Dehner

Basic hardwired connectivity of sensors and instruments has been a typical automation system design for manufacturing sites and original equipment manufacturers (OEMs) for a very long time. Hardwiring is straightforward, reliable, responsive, and well understood—even if it is a bit cumbersome.

This “keep it simple” hardwired approach is still appropriate in many cases, but three

drivers have been shifting user preferences toward wireless digital solutions:

- Smarter instruments
- Widespread use of fieldbuses and industrial protocols
- An increased need to access edge-located data.

When integrated well, these three concepts provide signaling equal to or better than

traditional methods but with many value-added benefits, such as simplified installation, enhanced diagnostics, and extended access to field data. The collective functionality of these elements is often termed as the Industrial Internet of Things (IIoT). While these three drivers ease IIoT implementations, some projects fall victim to incompatibilities or other issues, increasing design effort, or in the worst case, leading to unusable results.

**Through both positive and sometimes negative experiences, developers are finding that an IIoT scheme is only as good as the field-level communications technology it is built on.**

IIoT means different things to different users. Some just need to remotely view data. Or a machine OEM may want IIoT access to support their customers for troubleshooting. The most sophisticated users may need to historize and analyze extensive datasets to support optimization efforts, sometimes across fleets of equipment spanning many sites.

Through both positive and sometimes negative experiences, developers are finding that an IIoT scheme is only as good as the field-level communications technology it is built on. They are learning that it is better to build up IIoT capabilities incrementally from the edge, using proven methodologies and

products, than to jump too soon into the highest-level elements or try to execute a massive capital initiative.

This article points out ways that companies new to IIoT, often with smaller product lines or limited automation experience, can successfully start on the road to obtaining IIoT capabilities by building on a foundation of modern industrial field-level communications.

### Accessing data everywhere

The four main process automation analog measurements are flow, level, pressure, and temperature. Yet there are many others, including location, weight, and analytical values. In addition, there are important discrete signals, such as running, failed, in position, and more. Instruments and/or sensors are the field devices for detecting these conditions and transmitting diagnostics and related information to a control, asset management, or other host system.

Each of these signals can be connected using hardwired methods; however, all but the most basic field devices are likely to now be available with some level of digitalization and intelligence. These smart field devices can report much more data and status information, or receive instruction commands and configurations, if they are connected using a more advanced digital method commonly called a fieldbus.

A fieldbus is generally considered for operational technology (OT) spaces on-machine or throughout the plant floor, often in physically demanding locations. Connecting data to higher level control room or cloud

information technology (IT) resources usually requires an entirely different set of protocols developed for the unique transport and security needs of those systems.

Once a smart field device is connected using a fieldbus, it can deliver the primary measurement, along with extended information, such as device status, diagnostics, alerts, and configuration parameters. This additional information empowers users to implement more effective and sophisticated control schemes. Other data notifies users when there are issues and makes it easier for technicians to commission, troubleshoot, and otherwise support devices in operation. Higher level historizing and analytical applications can be used to great effect with this field device data.

### Getting on the bus

A fieldbus interacts with target field devices via copper for cable, a wireless network, or other media and the protocol, or language. Field devices usually support only certain fieldbuses, and often just one type. Fieldbuses must also be suitable for the installation environment and supported by the host system(s).

Available fieldbuses have taken many forms over the years:

- Serial communications like RS-232 using standard Modbus RTU or other protocols
- Digital communications on top of traditional hardwiring, such as HART over 4-20 mA
- Proprietary or open fieldbuses, such as Foundation Fieldbus, PROFIBUS, AS-Interface, IO-Link, and many others

- Ethernet media with industrial communications protocols, such as PROFINET, EtherNet/IP, Modbus TCP, HART-IP, and many others.

This is not a comprehensive list of fieldbuses, and there are also industrial wireless networking technologies, but it quickly becomes clear that there is no single fieldbus to rule them all. Simple discrete devices are not made to work directly with comparatively complex process fieldbuses, and advanced process instruments would also not work with fieldbuses tailored more to discrete devices.

On top of that, various field device vendors select the fieldbus they will support. Often, end users obtain complete equipment, such as process skids or machines, from multiple vendors, each of which has selected their own preferred makes and models of field instruments. While end users would always prefer to standardize, this is not always possible, so the only way to proceed in this environment is to establish flexible and adaptable methods of connecting field devices to higher level systems.

### Covering the bases

In an effort to start small at the edge, many designers are choosing familiar programmable

**Additional information empowers users to implement more effective and sophisticated control schemes.**







Figure 2. Modern PLCs natively work with the most popular OT fieldbuses and multiple IT-friendly protocols to make IIoT solutions practical for applications of all sizes.

One notable capability is that an IO-Link network can communicate simultaneously with both a supervisory PLC over EtherNet/IP, and with other site- or cloud-based systems using MQTT. A PLC can be used as a data concentrator, or IO-Link can communicate directly with higher level systems. This provides designers with the flexibility to implement capable local control, provide data

directly to other supervisory systems, and progressively implement any number of PLCs and IO-Link fieldbuses to scale up a complete IIoT solution (Figure 2).

### Pulling it all together

Field-level data sourced from intelligent sensors and other devices can provide a massive amount of valuable information, but

only if there are practical IIoT connectivity methods. OEMs and end users are leaning into IIoT technologies so they can monitor and analyze data to support asset management, maintenance, and optimization efforts. These endeavors are essential to better assist a dwindling operations workforce.

While these goals are well known, a wide variety of changing technologies and a scarcity of experienced design personnel can make it challenging to have confidence when moving forward with IIoT projects. This is especially true for smaller OEMs, and for less experienced developers. Acceptable

connectivity is just one issue, as designers must also consider ongoing support and security concerns.

For these and other reasons, many developers are finding it most effective to build up IIoT capabilities progressively, starting at the data source. Using modern digital fieldbuses like IO-Link, in conjunction with OT- and IT-capable PLCs, designers have the tools to begin implementing and scaling up IIoT projects, and then build on successes to create a complete system.

*All figures courtesy of AutomationDirect*



### ABOUT THE AUTHOR

**Bill Dehner** has spent the majority of his 17-year engineering career designing and installing industrial control systems for the oil and gas, power, and package handling industries. He has a bachelor's degree in electrical engineering with an associate degree in avionics from the USAF and is currently working for AutomationDirect as a technical marketing engineer.



International Society of Automation  
Setting the Standard for Automation™

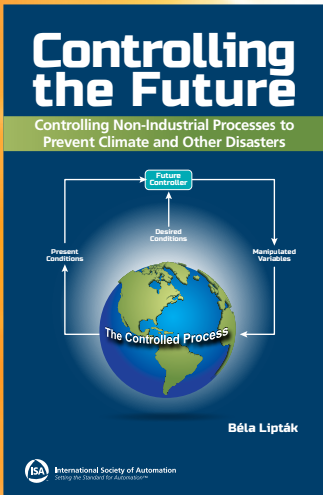

**Controlling the Future**  
Controlling Non-Industrial Processes to Prevent Climate and Other Disasters  
Béla Lipták

## Automation processes can affect the future of global warming

In his powerful book, *Controlling the Future*, author Béla Lipták, addresses the problem of global warming from an automation and control process perspective. Reviewing the effects of global warming and its timeline, the author discusses how such processes can be used to prevent disasters. This easy-to-read book is a must for anyone in automation or environmental studies who is interested in global warming and its effect on our future!

[Learn More](#)

# Advanced Analytics Drive Sustainability Initiatives



**Leverage models and algorithms to reduce costs, waste, and carbon emissions.**

**By Morgan Bowling**

In the era of Industry 4.0 and manufacturing digital transformation, data is at the core of every successful sustainability initiative. While most process manufacturers have been collecting time-series process data for decades, these projects cannot progress without historical context, a frequently lacking component.

Most manufacturers are using data management platforms to store and secure this information, but preparing these process data streams for analysis often does not occur. This step must be completed with both historical data and current/future data aggregation. Only then can subject matter experts

(SMEs) analyze this information to identify opportunities for operational optimization and help teams progress toward corporate sustainability initiatives.

While sustainability is recognized as an area of importance for almost all organizations, many are at a standstill because they lack the mechanisms to condition data for insightful analysis. They face obstacles accessing and connecting to their many disparate data sources, as well as cleansing and contextualizing the data. This prevents these companies from creating and operationalizing insights to increase operational efficiency and reduce emissions.

Fortunately, modern advanced analytics solutions are empowering process manufacturers to find, share, and act on insights derived from their seemingly endless data streams, helping operations and engineering teams drive sustainable practices.

### Challenges with antiquated data tools

As both the accessibility and volume of data increase, the limitations of legacy software options are becoming clearer: They simply cannot be counted on to find and operationalize data-based insights.

**While sustainability is recognized as an area of importance for almost all organizations, many are at a standstill because they lack the mechanisms to condition data for insightful analysis.**

The first challenge is accessing data. Process manufacturers have a variety of existing data sources across multiple databases hosted on-premises or in the cloud, such as process historians and asset management systems. Traditionally, teams have used standard spreadsheet-based tools to collect, cleanse, and align time series data from these sources to the best of their abilities. However, these efforts are labor- and time-intensive for the process experts, engineers, and data scientists typically tasked with the work.

After spending a significant amount of time compiling data in a spreadsheet, SMEs must analyze it to identify opportunities for environmental improvement. However, organizations cannot improve what they cannot measure. Spreadsheets lack a seamless method for visualizing and validating process data, making spreadsheet-based analysis cumbersome and error-prone, in addition to time-consuming. This prevents the deep analysis required to increase efficiency in process environments.

Without the right solutions, most sustainability metrics are either not calculated, inadequately monitored, or recorded too late, preventing operations teams from taking timely and informed action. This causes the organization to act in a reactive manner because issues are only brought to light

in reports that are often only prepared on a quarterly or annual basis. This prevents teams from proactively making operational changes to minimize or avoid emissions events.

### Software solutions support sustainability

With the right self-service advanced analytics solution, SMEs can gain insight into historical and near-real-time process data, including access to environmental parameters. Using these types of tools, teams can immediately

alleviate the challenges of live data connectivity, because the software automatically aggregates data from many types of disparate sources into a single platform. Automated data cleansing and contextualization enable engineers to significantly reduce the time spent preparing data for analysis and instead focus on process improvements like optimizing environmental performance.

Without data access and preparation barriers to worry about, SMEs can use purpose-built, point-and-click tools for descriptive, diagnostic, predictive, and prescriptive analytics to improve environmental performance based on reliable insights. Advanced analytics solutions incorporate visualization into the analysis workflow, empowering SMEs to see the impact of their analyses in near real time, pinpoint missteps, identify successes, and iterate and innovate more quickly than before.

Data visualization capabilities also make it easier to communicate environmental performance metrics efficiently. For example, teams can shift from reactive to proactive approaches by continuously monitoring parameters to detect and mitigate emission limit breaches. This helps facilitate rapid reactions to events while providing root cause assistance to SMEs.

In addition, by using advanced analytics solutions to build models and predict process behavior, the impacts of operational changes on an organization's environmental performance become apparent. For example, energy models based on steam generation and consumption in the plant can be referenced to change operations and reduce steam use, by extension reducing overall plant energy consumption (Figure 1).



**Figure 1.** Using advanced analytics, companies can model the impacts of operational modifications on such process variables as energy consumption to determine optimal conditions.

## INDUSTRY 4.0

The real-time collaboration capabilities facilitated by advanced analytics solutions help make sustainability a shared goal throughout an entire organization because insights and methods can be quickly communicated. This reduces information silos and alleviates calculation errors present when performing analysis using spreadsheets. Leveraging streamlined communication, knowledge capture, and reporting, these solutions enable organizations to maximize SMEs' effectiveness regardless of the time zone or work location.

### Justifying an idle boiler

To reduce carbon emissions and minimize environmental impact, process manufacturers must be able to identify time periods of wasteful operation and quantify the waste

as financial loss or CO<sub>2</sub> emissions equivalent. This allows companies to establish common benchmarks for comparing alternative operating strategies. These wasteful periods often occur in the form of vented steam or excessive electricity usage.

A major U.S. refiner executed a study using an advanced analytics solution to justify idling one of its boilers in a dual-boiler operation during the warmer months of the year. The company's data scientists configured the solution to identify time periods when the dual boiler system was operating at minimum firing rates while venting steam. After examining these wasteful periods, the team easily determined potential annualized steam savings (Figure 2).

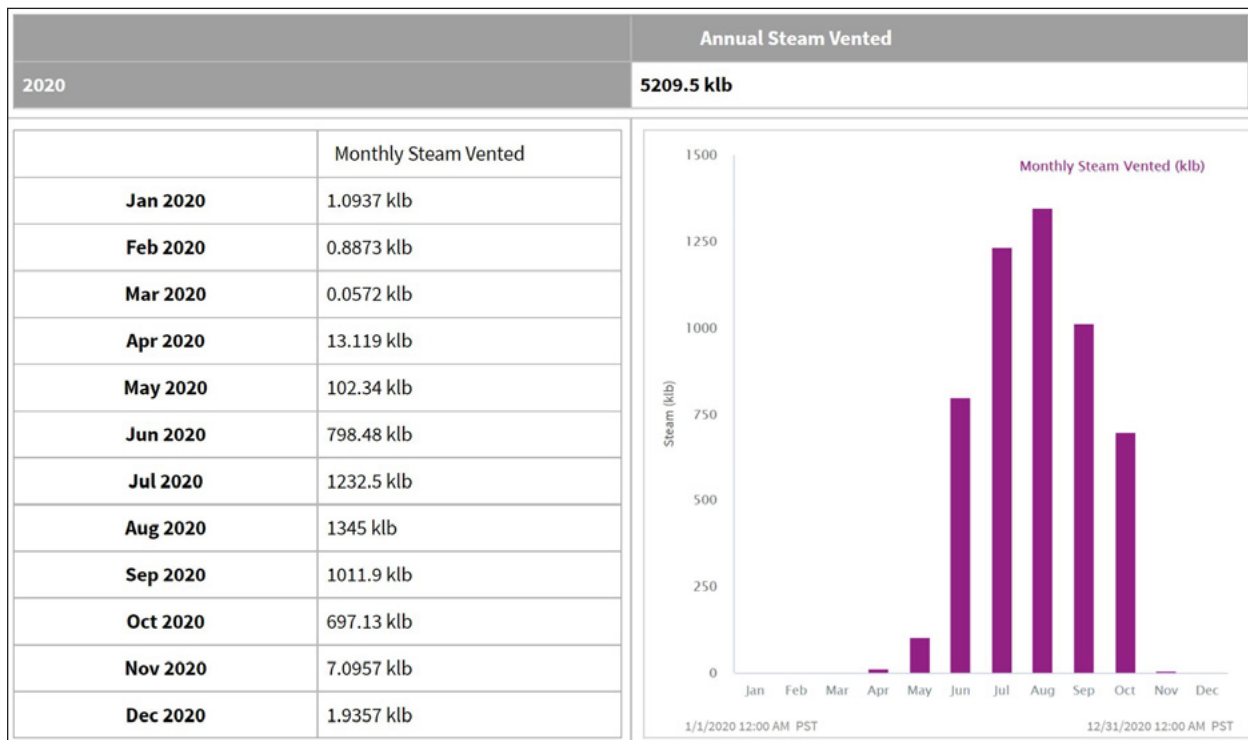

Figure 2. SMEs at a major refiner analyzed historical data to determine the best mode of operation for their boilers. To justify idling one boiler in a dual-boiler operation, they quantified the probability of a boiler trip, then weighed the risk—defined as failure probability multiplied by financial consequence—against the steam and energy savings of running a single boiler.



As a result of the analysis, the SMEs determined that idling one of the boilers during prolonged periods of warm weather would save the refiner significant vented steam costs. Operationalizing this insight has reduced expenditures by an average of \$500,000 each year, and it also lessened the company's carbon footprint by decreasing the energy required to run the boiler system.

### Reducing carbon emissions

A global chemical manufacturer pledged to cut its carbon intensity in half by 2030. The first step toward this ambitious goal was understanding the current state of operations, an analytics activity that was previously so cumbersome that the company only executed it once a year. However, carbon intensity calculations provide critical insights about overall carbon footprint and emissions that were necessary to efficiently progress toward the company's sustainability goals.

By deploying advanced analytics, engineers gained real-time awareness of site utility stream carbon intensity. Within the solution, SMEs converted process sensor data into carbon mass equivalencies to enable comparison of current versus target carbon intensity for a given production quantity. Breaking up the carbon footprint into individual utilities

**Without the right solutions, most sustainability metrics are either not calculated, inadequately monitored, or recorded too late.**

enabled operations teams to understand the most significant contributors when operating in excess of the target, as well as the leverage to combat them.

These overall carbon intensity estimates empowered the chemical manufacturer to

### Webinar: Accelerate Sustainability Outcomes

Top organizations are leveraging their existing data infrastructure to gain new visibility into their operations and reach their sustainability goals. Optimize energy efficiency and minimize emissions. Morgan Bowling, industry principal at Seeq, and Anthony Teodorczuk, technical support and operations manager at SBM Offshore, discuss key sustainability initiatives and dive into use cases of best practices around emissions monitoring and reporting. In [the webinar](#), the two discuss:

- Key sustainability challenges focused on the availability and access to data
- How organizations can accelerate their path to sustainable operations
- Actionable steps to drive progress towards net zero emissions by optimizing energy efficiency, minimizing environmental impact, and streamlining regulatory reporting.



make data-driven decisions to target carbon reduction on an ongoing basis, making measurable progress toward its 2030 goal. Building a culture of carbon reduction driven by analytics also helped the company emerge as a chemical industry leader in sustainability.

### Economic returns and competitive differentiation

There is no doubt that sustainability initiatives will continue to drive incremental and transformational change. The adoption of runtime measurement and validation facilitates movement toward increasingly proactive production systems, which help establish dynamic mitigation and preemptive detection of emission events.

The actions of individual companies have consequences beyond the fence of a plant, or boundaries of the enterprise. Sustainability initiatives impact everyone and also create opportunities for differentiation and competitive advantage, especially in industrial and manufacturing markets. With digital technologies

and modern analytics solutions, runtime visibility is plausible and common, empowering organizations to confidently control inputs that drive desired results.

Many manufacturing companies are leveraging process data in their quest for operational excellence, and more are beginning to use it in sustainability initiatives as well. This trend will continue, because company bottom lines can no longer solely depend on high throughput and maximum profitability—environmental impact and recognition must also be considered.

Regardless of the industry, sustainability-focused projects need not require significant capital investment. Instead, organizations can make positive environmental adjustments by analyzing their data to create insights and make better use of existing assets. By applying self-service advanced analytics to operational data, organizations can continue to pursue ambitious carbon neutrality goals that will foster sustainable practices for generations to come.

*All images courtesy of Seeq*



#### ABOUT THE AUTHOR

**Morgan Bowling** is an industry principal at [Seeq](#). She has a process engineering background with a BS in chemical engineering from the University of Toledo. Bowling has nearly a decade of experience working at both independent and integrated major oil and gas companies to solve high-value business problems leveraging time series data. In her current role, she enjoys monitoring the rapidly changing trends surrounding digital transformation in the process industries and translating them into product requirements for Seeq.

# How Additive Manufacturing Leads to Quieter Control Valves

By Grady Emswiler and Mike Hoyme

## 3D printing techniques enable quieter, higher performing designs for final control elements.

Control valve noise is a problem in many plant environments. The sound is created by very high pressure drops across a valve, which generates high vapor velocities as the fluid moves through the narrowed passages in the valve body. Aerodynamic noise has a strong dependence on the gas velocity, so high flow and high pressure drop applications tend to reach deafening sound levels very quickly. This type of noise can damage hearing, and over time, it can destroy tubing, sensitive

equipment, nearby piping connections, and valve components.

Low noise trim designs have been historically used to address this issue, but these types of solutions are usually costly and greatly reduce flow capacity. However, additive manufacturing techniques (3-D alloy printing) have introduced a whole range of new possibilities in noise reduction solutions. This article describes new designs that have

been recently introduced or are slated to become available in the next few months.

## A noisy problem

Plants are full of loud noise sources, including large equipment, process vents, and reciprocating pumps. Many of these sounds are point sources (Figure 1, top) and the sound levels fall off as the square of the distance. Control valves are another common source of sound in industrial environments, but in this case the sound actually emanates from both the valve and the pipe, creating a linear source when the downstream pipe is long enough (Figure 1, bottom). While a point source loses sound intensity with the square of the distance, a linear source drops intensity directly proportional to the

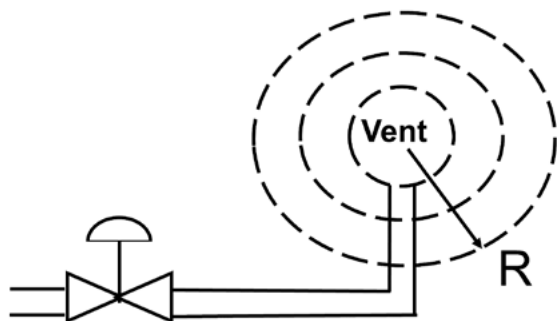
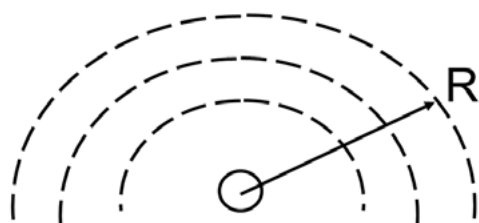

Figure 1. Noise point sources (top) lose sound energy quickly, falling with distance squared. Control valve noise (bottom) radiates sound from the pipe itself, as depicted in this piping cross section, so the sound levels drop much more slowly with distance.



distance, so it tends to create larger problems for plant personnel.

Common causes of control valve-generated noise include mechanical vibration of internal components, aerodynamic noise from turbulent gas flow, and hydrodynamic noise from cavitation. The sound external to the pipe poses a threat to hearing at levels above 85 dBA, and levels above 110 dBA can damage valve components and adjacent piping connections, and should thus be avoided (Figure 2).

There are usually two ways to address this problem—either restricting the sound path so the sound cannot escape to the environment or eliminating the generation of the sound at the source. Sound path solutions commonly employ thick pipes, heavy insulation, and/or acoustic blankets to block the noise. These work well and are inexpensive, but these solutions have limitations.

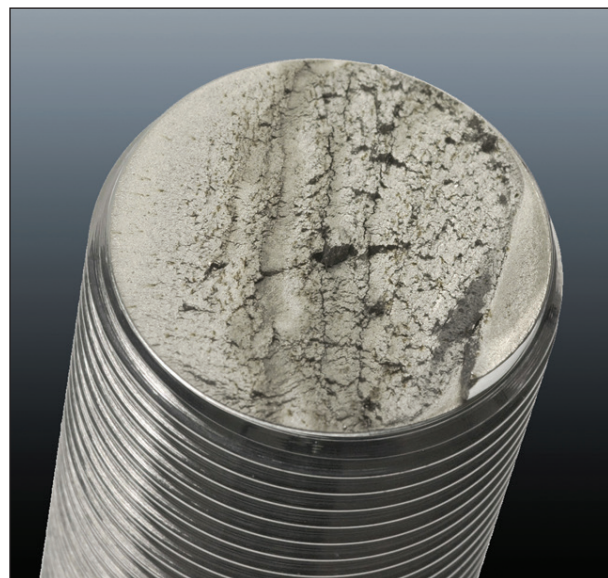

Figure 2. Control valve noise above 110 dBA external to the pipe can fatigue bolts and ultimately crack control valve stems and shafts. For this reason, sound levels should be kept below this threshold.

The achievable noise reduction is usually somewhat limited, and these techniques tend to become less effective over time as insulation breaks down and acoustic blankets are removed during maintenance and not reinstalled correctly. Regardless of how well they work, sound path solutions do not address the fundamental problem of sound levels greater than 110 dBA possibly damaging the equipment.

### Calming the beast

The standard solution for control valve noise has been the installation of quiet valve trims to reduce the levels of noise generation at the source. These designs usually break up the flow into multiple flow paths, or they take smaller pressure drops across multiple stages, to reduce overall flow velocity and depress overall sound levels. This technology also works well, but it too has limitations:

- Low noise trims tend to restrict valve flow capacity significantly, requiring larger valve bodies to pass the same flow rate.
- Low noise trims are typically much more expensive than standard valve trims since intricate machining is required to produce these designs.
- Low noise trims often have limited applicability for rotary valves.

The landscape of control valve noise solutions has changed dramatically with the advent of additive manufacturing because it is now possible to quickly and economically create very complex trim configurations. This recent capability has spurred new noise reduction solutions that can achieve very high

levels of noise reduction while maintaining high flow capacity.

### Rotary valve low noise trims

Rotary valves tend to be much less expensive than globe valves, but they are inherently prone to higher noise levels due to their trim configuration. It is difficult to incorporate any kind of noise reduction trim into the valve since the full pressure drop is taken across the ball. For this reason, rotary valves are not usually employed in high pressure drop/high noise applications.

Fortunately, additive manufacturing has enabled entirely new trim configurations that can reduce sound levels significantly (Figure 3). For example, in-ball attenuators produced using additive manufacturing can provide up to 18 dB of sound level reduction for next generation rotary trims. These noise reduction levels are achieved while largely maintaining the high flow capacities common with rotary valves. This can save significant costs over globe valve alternatives in a typical application.



**Figure 3. Innovative additive manufactured rotary valve solutions can reduce sound levels up to 80 percent over traditional manufactured designs.**

## Advanced globe valve trim designs

A wide selection of low noise trims is available in globe valves, each using a progressively more complicated trim configuration to produce higher levels of noise reduction. Usually, the more complex the trim style, the higher the noise reduction and cost, and the lower the flow capacity. Very high noise reduction levels have historically only been achieved at very high cost and by grossly restricting flow capacity through the valve. If high flow capacities are required, a much larger valve body has been necessary when using standard low dB trim designs.

A new generation of trim styles is entering the market to address the flow capacity problem (Figure 4). These new styles employ very complex flow passages and have only recently been made possible through additive manufacturing.

These innovative designs achieve very high levels of control valve noise reduction by creating numerous flow passages and more efficient

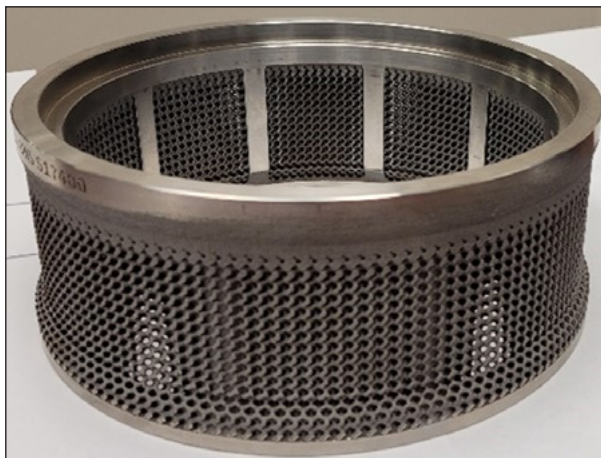

Figure 4. Innovative additive manufactured globe valve solution that meets or exceeds traditional manufactured noise reduction with 20 percent higher flow capacity.

pressure drop stages, reducing overall noise generation and shifting much of the sound to higher, less destructive frequencies. Despite the very high sound level reduction, the designs maintain high flow capacity through the valve. This allows smaller, less costly valve sizes to be used for a given application.

The same additive manufacturing technology can also be used to create trim designs that achieve the very highest levels of sound reduction (Figure 5). These trims do sacrifice flow capacity, but they can be employed in very difficult applications where traditional noise reduction solutions are inadequate. These low noise trim designs round out a suite of existing low dB solutions that can be used to address a broad spectrum of noise reduction, valve capacity, and installed cost requirements.

## Modal attenuator

An option already on the market uses an entirely different means of reducing control valve noise. It is a passive device that employs similar concepts as car mufflers, using

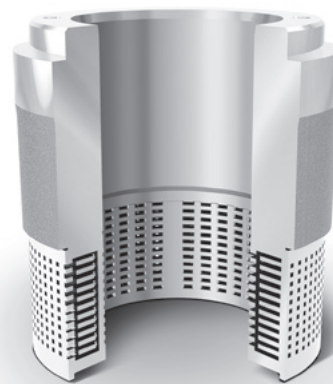
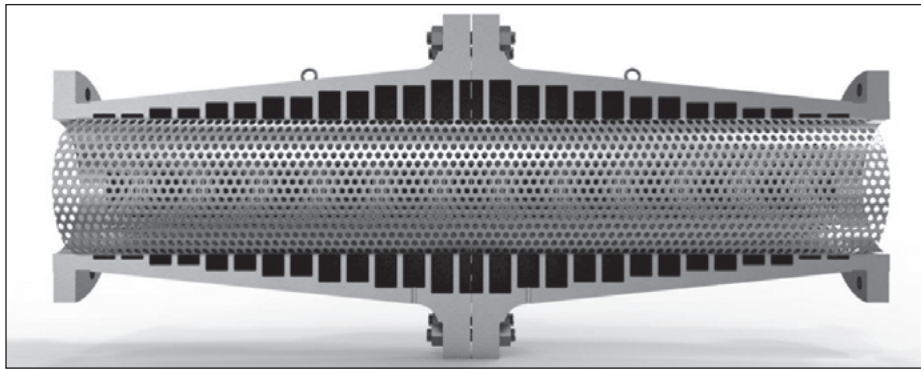

Figure 5. When extreme noise reduction is required, solutions are available that can be used to achieve noise reduction levels as high as 40 dB.



**Figure 6.** This modal suppressor employs a series of varying sized chambers to generate destructive interference over a range of frequencies, with virtually no pressure drop.

destructive sound resonance to offset and cancel noise (Figure 6). First conceived in the 1980s as a college research project, the technology was shelved for decades until recently when additive manufacturing made it economically possible to develop a pattern to produce the component as a cast assembly.

The modal attenuator consists of a series of carefully engineered resonant cavities to provide sound reduction across a wide spectrum of frequencies. The full-bore design allows unrestricted flow, and internal drain channels drain off condensate that could build up in the device and reduce performance. Installed just downstream of the valve, the modal attenuator achieves an overall sound reduction of up to

15 dBA while creating no restriction in flow capacity whatsoever. The device can be used on existing valves or paired with a low noise control valve to achieve even higher levels of noise reduction. Unlike diffusers or silencers, the modal attenuator works consistently across a wide range of flow rates.

### Evaluate the options

When faced with a control valve noise problem, it is worth taking the time to investigate the many new options that have recently become available or are being introduced. Additive manufacturing has greatly broadened the landscape of what is possible.

*All figures courtesy of Emerson*



#### ABOUT THE AUTHOR

**Grady Emswiler** is a product marketing manager for Engineered Products at [Emerson](#). Although new to the company, she has a background in product marketing in different industries. Emswiler has a Bachelor of Science degree in marketing from Iowa State University.



**Mike Hoyme** is a product manager for [Fisher Rotary Valves](#). He is a certified functional safety professional with 10 years of valve engineering and product management experience, and he strives to create final elements for safety instrumented systems (SIS) that both improve safety and process uptime. Hoyme has a Bachelor of Science degree in mechanical engineering from the South Dakota School of Mines and Technology.

## ISA Cybersecurity Summit Debuts in Scotland

ISA is hosting its new [OT Cybersecurity Summit](#) in Aberdeen,

Scotland. Focused on the rapid growth of operational technology (OT) cybersecurity challenges and opportunities, the live event on 31 May and 1 June 2023 will include global perspectives on supply chain and threat intelligence. Related training sessions will be available on 29 and 30 May at the same location: the Ardoe House Hotel & Spa.

Much of the oil and gas production from the UK Sector of the North Sea is considered critical infrastructure. Because of its importance to the security and prosperity of the UK, these operations are coming under increased regulatory scrutiny. "Aberdeen is an ideal location to bring together stakeholders from across the oil and gas industry and its supply chains for a productive and informative conversation about how to identify and mitigate cybersecurity vulnerabilities," said Claire Fallon, ISA executive director.

The OT Cybersecurity Summit is an opportunity for operators, service companies, regulators, and equipment providers to meet face-to-face. This two-track, two-day event is organized around two major topics, supply chain and threat intelligence, with additional panel discussions on supply chain risk management and understanding ISA/IEC 62443.

Keynote speakers for the event include Cheri Caddy, Deputy Director at the US Office of the National Cyber Director, and

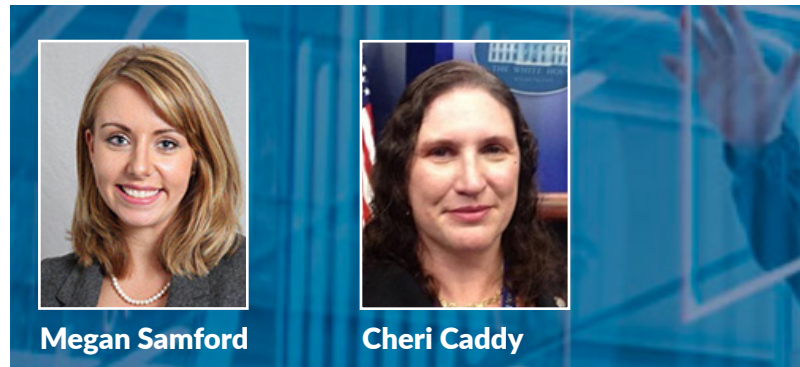

Megan Samford

Cheri Caddy

Megan Samford, Vice President and Chief Product Security Officer for Energy Management at Schneider Electric. Additional speakers include subject matter experts from Saudi Aramco; Johns Manville; US Department of Homeland Security; UK National Cyber Security Centre; UK Department of Digital Culture, Media, and Sport; ENGIE Electrabel; and Au2mation.

"The ISA community is comprised of the world's leading voices on industrial cybersecurity, and we are proud to have developed ISA/IEC 62443, the standard behind the most robust and secure operational technologies," said Fallon. "The ISA OT Cybersecurity Summit stands apart from other cybersecurity events as a venue where attendees can gain practical knowledge about the standard and best practices for its implementation."

In addition to developing and maintaining the [ISA/IEC 62443](#) standards, ISA offers training and credentialing on cybersecurity; certifies products, processes, and systems through its [ISASecure](#) certification; and raises awareness about the importance of OT cybersecurity through its membership consortium, the [ISA Global Cybersecurity Alliance \(ISAGCA\)](#).

# ISA Business Academy: Delivering a Mini-MBA for Automation Professionals

ISA has announced its newest resource for ISA members: a 10-week, fully virtual program with content based on an MBA curriculum. The ISA Business Academy is designed for current and future leaders of the automation industry to master the skills of organizational leadership, people management, and business finance.

The ISA Business Academy program includes more than 20 hours of video, a private learning community, and a resources library. After joining the ISA Business Academy, students receive access for a year to:

- 6 hours of live facilitated expert coaching
- More than 350 modules within the self-paced online learning
- Connection to a cohort of fellow business leaders
- Downloadable companion worksheets and materials
- 20 interactive tools for implementing what is learned
- “Knowledge checks” to build competency
- Access to video modules and additional resources

ISA is known for its [world-class training](#) and quality instructors. ISA Business Academy instructors include automation business expert Eddie Habibi and automation finance expert Scott Reynolds, PE, CISSP.

ISA Executive Board Member Eddie Habibi founded and led PAS, an industrial automation software company, through 2020. He is the co-author of two popular best-practices books on industrial operator effectiveness: *The Alarm Management Handbook* and *The High-Performance HMI Handbook*. Prior to establishing PAS, Habibi held various positions at Schlumberger and Honeywell International. He holds an Engineering degree from the University of Houston and an MBA from the University of St. Thomas.

ISA Past-Treasurer Scott Reynolds is an experienced IT/OT manager with a demonstrated history of working in both municipal and manufacturing environments with a focus on industrial cybersecurity. Scott is passionate about IT/OT collaboration, workforce development, strategic planning, and development

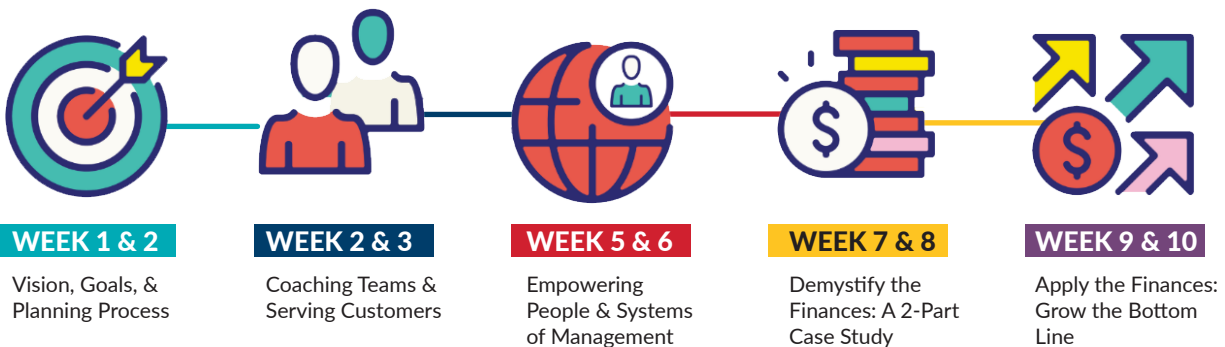

**ISA Business Academy is a fully virtual program designed for automation professionals who want to improve their organizational leadership, people management, and business finance skills.**



of reasonable and useful corporate standards for process control networks. His current role is as senior security and networking engineering manager at Johns Manville in Denver.

ISA created the ISA Business Academy with the help of John Cioffi, who has spent 30 years coaching hundreds of clients to success through his GoalMakers “master manager”

programs. Cioffi previously ran a subsidiary of Amoco Oil and held executive positions at several other companies. He received his MBA from The Wharton School and holds a Master’s from Dartmouth.

The first 20-week program begins 31 August 2023. More information is available at <https://goalmakers.com/isa>.

## International Automation Professionals Celebrated in April



### #AutomationProDay

For the second year in a row, the International Society of Automation (ISA) honored automation professionals with a digital celebration through the entire month of April.

Each year, ISA and its global community celebrate 28 April as International Automation Professionals Day. The day commemorates ISA’s founding on 28 April 1945, and celebrates the wide range of folks engaged in industrial automation and cybersecurity that the association serves.

Because this is a digital celebration, automation professionals around the world participated in International Automation Professionals Day all month long.. Career-established individuals, entry-level personnel, and automation students were encouraged to engage with ISA on social media (#IAPD or #AutomationProDay) with images and testimonials that feature them on the job, studying for their automation-related major, or giving statements about why they enjoy their line of work and why they believe automation is changing the world.

ISA Executive Director Claire Fallon said that the automation field is vital to many sectors, and the day celebrates the hard work of professionals who are instrumental in keeping society safe and secure.

“I want all automation professionals to know that they make the world a better place,” she said. “Because of them, the world is safer, more efficient, and more effective. Professionals are the people, not the machines, that creatively look at a problem and tenaciously tackle it from every angle until the best solution is found.”

ISA President Marty Bince said that those in automation play a vital factor in life’s modern-day conveniences, and he is happy to highlight their achievements. “This will be a time to celebrate all the outstanding opportunities that automation professionals have and the contributions they make,” he said. “From power production to smart manufacturing, instrumentation, and digitalization, automation professionals play a crucial role in ensuring the reliability, safety, efficiency and competitiveness of our businesses for all the things that make life wonderful.”

## ISA Security Compliance Institute Welcomes IriusRisk SL

The ISA Security Compliance Institute (ISCI) announced that IriusRisk SL has joined ISCI as a Technical Member in support of the ISASecure Cybersecurity Conformance Scheme.

IriusRisk has worked with several organizations to help them overcome the complexity of manual threat modeling with the IriusRisk Automated Threat Modeling platform, an automation engine that incorporates extensive security standards and integration with major issue trackers. As a result, engineering teams using the platform have access to a self-service tool for designing secure applications.

Andre Ristaino, ISA Managing Director of Consortia and Conformance Programs, said, “Companies like IriusRisk are key to enabling adoption of the ISA/IEC 62443 standards for supplier companies. Commercial tools that simplify the threat analysis and

compliance tasks during product development remove barriers to applying the ISA/IEC 62443 standards.”

The [ISASecure certification program](#) is an industry-led effort by leading stakeholders in the process industry. It assesses ICS products and systems to ensure that they are robust against network attacks, free from known vulnerabilities, and meet the security capabilities defined in the ISA/IEC 62443 standards.

Charles Marrow, Head of Center of Excellence at IriusRisk, considers ISCI’s pursuit of better security standards across a broad range of industries “important work.”

“All organizations operating in the industrial, automotive, transport, and medical industries should be doing [threat modeling and risk assessments] on a regular basis, building in security from the very beginning of the software development lifecycle,” Marrow said.

## ISA Standards and the International Standards System

*ISA actively participates in the world’s primary international standards system as sanctioned by the United Nations and operated by the Geneva-based International Electrotechnical Organization (IEC) and International Organization for Standardization (ISO). This relationship with IEC and ISO adds a layer of complexity to the sometimes confusing world of standards. InTech asked ISA Senior Director of Standards Charley Robinson to explain.*

Much of the confusion arises from the fundamentally different member structures

involved in ISA standards development, as opposed to IEC/ISO. Participation in ISA standards is based strictly on individuals and is open to automation professionals from any country, not just the United States. IEC and ISO programs, in contrast, are based on participation by and through countries acting as single members.

That difference means that ISA cannot participate directly in the IEC/ISO systems, but rather must channel its input through a specific country to do so. That country is the

United States by way of the American National Standards Institute (ANSI). ISA is accredited by ANSI to develop industry standards following approved processes that ensure openness and balance. ISA is one of 250+ standards developing organizations based in the United States, such as ASTM, ASME, and UL, that are accredited in this way by ANSI.

In relation to the IEC and ISO, ANSI serves as the official “national standards body” of the United States. That is, ANSI acts as the official representative (“National Committee”) to the IEC and ISO of those 250+ accredited U.S. standards developers. Similarly, other IEC and ISO members are the national standards bodies of participating countries such as Brazil (ABNT), the UK (BSI), Japan (JISC), Canada (SCC), and Germany (DKE).

Because of the topic division between the IEC and ISO, ISA’s primary areas of standards development are covered by the IEC. Through ANSI as the “US National Committee to the IEC,” several ISA standards series have been submitted to the IEC to become the basis of major IEC standards series with the same titles (see box for a list).

This development of ISA standards into IEC standards is the primary, but not only, means of interaction between ISA and IEC—occasionally, ISA standards committees decide, through review and voting, that existing IEC standards are suitable for adoption (sometimes with modification) as ISA standards. For example, in 2018, the ISA84 committee adopted IEC 61511-2016 (which had been developed by IEC committee SC65A with substantial input from ISA84 members) as ISA-61511.

This type of adoption of an IEC standard by an ISA committee can create another source of confusion for ISA members. A major attraction and benefit of ISA membership is [free viewing of ISA-copyrighted standards](#). However, when ISA standards committees decide to adopt an existing IEC standard as an ISA standard, such as the example of ISA84 and IEC 61511), the controlling copyright of the adopted standard (ISA-61511 in the example) remains with the IEC. For that reason, ISA members do not have free viewing access to IEC standards that have been adopted by ISA (ISA-61511 in the example). This restriction, which applies only to the small number of ISA standards adopted from the IEC, is driven by copyright law.

Have more questions about standards? Visit [www.isa.org/standards](http://www.isa.org/standards).

### ISA Standards That Are Also IEC Standards

- IEC 62682: Management of Alarm Systems for the Process Industries (ISA-18)
- IEC 61511: Functional Safety—Safety Instrumented Systems for the Process Industry Sector (ISA-84)
- IEC 61512: Batch Control (ISA-88)
- IEC 62264: Enterprise-Control System Integration (ISA-95)
- IEC 62443: Security for Industrial Automation & Control Systems (ISA-99)
- IEC 62734: Wireless Systems for Industrial Automation (ISA-100)
- IEC 63303: Human-Machine Interfaces for Process Automation Systems (ISA-101)

# Work@Home Is Environmentally and Sustainably Responsible

By Bill Lydon

Employees working primarily at home can have an important impact on improving the environment and contributing to increased sustainability. A fundamental energy conservation concept I was taught years ago is that the best unit of energy is the one you don't use. Since work from home obviously saves energy and lowers carbon emissions, it follows that sensible work-from-home policies should be part of company commitments to the environment and to sustainability. However, I have been surprised at the number of companies promoting their Environmental, Social, and Governance (ESG) commitments while at the same time requiring employee time in the office.

Many public companies have positioned themselves as ESG-investable and diligently report their commitments to a variety of ESG targets. ESG investing refers to a set of standards for a company's behavior used by socially conscious investors to screen potential investments.

Environmental criteria, for example, considers how a company safeguards the environment or addresses climate change. It also encompasses efficient water and energy use, carbon accounting, and environmental management systems. Social criteria examine



how a company manages relationships with employees, suppliers, customers, and the communities in which it operates. Governance deals with a company's values



and behavior regarding leadership, executive pay, audits, internal controls, and shareholder rights.

### The value of virtual meetings

The COVID pandemic has proven the effectiveness of leveraging technology for virtual meetings and online collaboration. In my experience overall, virtual meetings have enhanced knowledge and creativity while allowing participants to interact with a much broader audience, often throughout the world, in small and large online group meetings. These types of interactions in most cases would not be practical just five years ago; now we have a wide range of significantly effective collaboration and communications technologies.

In the United States, passenger cars account for more than 40% of greenhouse gas emissions, followed by air travel at 10%. In addition, nonresidential buildings contribute a significant amount of greenhouse gas emissions. The pandemic derailed commuting and gave Americans back 60 million hours that had been spent in standstill traffic or a jam-packed train car, according to new research from the New York Fed.

In my experience, work from home provides a significantly better work environment, particularly for knowledge workers who have

access to quiet space and more natural light. Certainly, there is the need for occasional face-to-face meetings, but these often can be accomplished using hybrid approaches coupled with only going to an office occasionally. The idea that people need to be in the office “with the bosses watching” to be productive is a management issue too deep to discuss in this short article.

Of course, there are jobs that require people to be on-site. During the pandemic, however, when the number of people on-site was limited, numerous reports and articles documented how productivity increased using remote/virtual technologies. In industry, for example, subject matter experts located anywhere could collaborate with operations people on-site to solve problems. This approach maximizes the effectiveness and productivity of the limited number of subject matter experts. Automation professionals are important for making remote/virtual collaboration happen effectively.

Sensible and balanced work-from-home policies are consistent with socially responsible companies to achieve environmental and sustainability goals and commitments. This should be part of company commitments to be environmentally and sustainably responsible.



#### ABOUT THE AUTHOR

**Bill Lydon** is an *InTech* contributing editor with more than 25 years of industry experience. He regularly provides news reports, observations, and insights here and on [Automation.com](http://Automation.com).